

**AN ORDINANCE TO AUTHORIZE AND APPROVE TWO ONE-YEAR EXTENSIONS OF CONTRACT 22029PW (STREET PAVING PHASE X) BETWEEN THE CITY OF WILMINGTON AND SAM'S CONSTRUCTION, LLC**

---

#0244

Sponsor:

Council  
Member  
Oliver

WHEREAS, pursuant to Section 2-308 and Section 8-200 of the City Charter, the City of Wilmington is authorized to enter into contracts for the supply of personal property or the rendering of services for a period of more than one year if approved by City Council by ordinance; and

WHEREAS, the City publicly advertised the specifications for Contract 22029PW "Street Paving Phase X" (the "Contract") in accordance with the requirements of Section 8-200 of the City Charter, and subsequently awarded the Contract, a copy of which, in substantial form, is attached hereto and incorporated by reference herein as Exhibit "A", to Sam's Construction, LLC, the lowest responsible bidder; and

WHEREAS, the term of the Contract is for the period from approximately June 27, 2022 through June 26, 2023, at an estimated price of Two Million Seven Hundred Eleven Thousand Seven Hundred Sixty-Two Dollars and Seventy Cents (\$2,711,762.70) with the possibility of two (2) extensions of one (1) year thereafter upon the same terms and conditions; and

WHEREAS, it is the recommendation of the Department of Public Works that Council authorize the City to exercise the options to extend the Contract for two (2) additional periods of one (1) year.

**NOW, THEREFORE, THE COUNCIL OF THE CITY OF WILMINGTON HEREBY ORDAINS:**

**SECTION 1.** The two (2) one-year extension options to Contract 22029PW "Street Paving Phase X" between the City of Wilmington and Sam's Construction, LLC, a copy of which Contract, in substantial form, is attached hereto as Exhibit "A", at an estimated price of

Two Million Seven Hundred Eleven Thousand Seven Hundred Sixty-Two Dollars and Seventy Cents (\$2,711,762.70) per extension, are hereby approved, and the Mayor, or his designee, is hereby authorized to exercise the City's options, as well as to take all additional undertakings related thereto, as may be necessary.

**SECTION 2.** This Ordinance shall become effective upon its passage by City Council and approval by the Mayor.

First Reading.....November 3, 2022  
Second Reading.....November 3, 2022  
Third Reading.....

Passed by City Council,

\_\_\_\_\_  
President of City Council

ATTEST: \_\_\_\_\_  
City Clerk

Approved this \_\_\_\_ day of \_\_\_\_\_, 2022.

\_\_\_\_\_  
Mayor

**SYNOPSIS:** This Ordinance authorizes the City to exercise two (2) one-year extension options for Contract 22029PW "Street Paving Phase X" with Sam's Construction, LLC.

**FISCAL IMPACT STATEMENT:** The fiscal impact of this Ordinance is two (2) one-year contract extensions at an estimated price of Two Million Seven Hundred Eleven Thousand Seven Hundred Sixty-Two Dollars and Seventy Cents (\$2,711,762.70) per extension.

# EXHIBIT A



Street Address: (302) 324-2500  
950 West Basin Road (800) 235-9100  
New Castle, DE 19720

Mailing Address: Legal Desk:  
P.O. Box 15505 (302) 324-2676  
Wilmington, DE 19850 Legal Fax:  
302 324-2249

SD CITY WILM PURCHASING DIV  
800 N FRENCH ST FL 5

WILMINGTON, DE 19801

DE,

## AFFIDAVIT OF PUBLICATION

**State of Delaware**  
**New Castle County**

Personally appeared **The News Journal**

Of the **The News Journal Media Group**, a newspaper printed, published and circulated in the State of Delaware, who being duly sworn, depose and saith that the advertisement of which the annexed is a true copy, has been published in the said newspaper 2 times, once in each issue as follows:

01/06/22, 01/13/22 A.D 2022

Linda Kennedy

*Melanie Altz*

Sworn and subscribed before me, this 13 day of January,  
2022

Ad Number: 0005072628

Legal notification printed at larger size for affidavit.



Ad Number: 0005072628

Run Dates: 01/06/22, 01/13/22

The City of Wilmington will receive sealed bids  
at the Division of Procurement & Records, 5th Fl., Louis L. Redding Bldg.,  
800 French St., Wilmington, DE 19801 for:

**22029PW – STREET PAVING PHASE X**

**Bids Due: Thursday, February 10, 2022, at 3:00 p.m., to the Procurement  
Division 5th Floor, Louis L. Redding City/County Building, 800 French  
Street, Wilmington, DE 19801. Bids can also be left in the drop box  
marked "PROCUREMENT" located on the first floor in front of the guard  
station.**

**Bid opening: Zoom Meeting, Feb 10, 2022 03:00 PM**  
<https://zoom.us/j/99788575035?pwd=Sk5vcHJWYzRJamxrZ3luN1pFemxPQT09>

Meeting ID: 997 8857 5035      Passcode: Jr4EMS

Specifications may be requested by email to  
[procurement@wilmingtonde.gov](mailto:procurement@wilmingtonde.gov).  
Philip Ceresini  
Purchasing Agent II  
Division of Procurement and Records  
Department of Finance

[pceresini@wilmingtonde.gov](mailto:pceresini@wilmingtonde.gov)  
[www.wilmingtonde.gov](http://www.wilmingtonde.gov)

1/6, 1/13-NJ

---

0005072628-01

## INSTRUCTIONS TO BIDDERS

1. Bids on **City Contract 22029PW – STREET PAVING PHASE X** are due to the Department of Finance, Division of Procurement and Records, 5<sup>th</sup> Floor, Louis L. Redding City/County Building, 800 French Street, Wilmington, Delaware by **3:00 PM on February 10, 2022**. **Bids can also be left in the drop box marked “PROCUREMENT” located on the first floor in front of the guard station.**

The building is still closed to the public so the bid opening will be visible as a Zoom Meeting.

Link: <https://zoom.us/j/99788575035?pwd=Sk5vcHJWYzRJamxrZ3luN1pFemxPQT09>

Meeting ID: 997 8857 5035 Passcode: Jr4EMS

2. Proposals must be in triplicate, sealed in an envelope, and the envelope endorsed "**Bid for City Contract 22029PW – STREET PAVING PHASE X**" and addressed to the Department of Finance, Division of Procurement and Records, 5<sup>th</sup> Floor, Louis L. Redding City/County Building, 800 French Street, Wilmington, Delaware.

3. Any bid may be withdrawn prior to the schedule time for opening of bids or authorized postponement thereof. No bid may be withdrawn within thirty (30) calendar days after the actual opening thereof.

4. The successful bidder will be required to have or obtain an appropriate business license from the Department of Finance, Revenue Division, City of Wilmington, in order to be awarded the contract. Before obtaining a City of Wilmington Business License, all applicants must show proof of a current State of Delaware Business License.

5. No bid will be considered unless accompanied by a Certified Check (personal check, cashier's check, or treasurer's check are not acceptable) or a good and sufficient Bid Bond to the City of Wilmington in the amount of not less than 10 percent of the amount of the base bid, plus all additive alternatives, with Corporate Surety authorized to do business in the State of Delaware.

6. The Bid Bond must be accompanied by a certification attached hereto, issued by the Surety Company, qualified to do business in the State of Delaware, and satisfactory to the Owner, which certification contains the commitment of the Surety Company to execute a 100 percent Performance and/or Labor and Materials Bonds to cover the bidder's performance and its' payments of labor and materials if the bidder is successful and the contract is awarded to him. The successful bidder must furnish the above bond within ten days after the award of contract.

7. If a corporation, the successful bidder shall furnish a certificate from the State where it is incorporated, stating that it is a subsisting corporation. The corporation shall also furnish one (1) original and two (2) copies of the excerpts of the corporate minutes which grant authority to those who sign and attest the contract. The Corporate Seal shall be affixed where signatures are attested.

8. The successful bidder will be required to withhold City of Wilmington Wage Tax from their employees and withheld taxes paid to the City of Wilmington pursuant to the provisions of the Wilmington Wage Tax Law. This law applies to people living and/or working in the City of Wilmington.

9. Bidders are required to refer to the delinquent tax clause appearing on page GC-21 of the General Conditions.

10. The successful bidder certifies that they are not listed on the Federal Government, Excluded Parties List System ([www.sam.gov](http://www.sam.gov)). This will be verified by the City of Wilmington and if listed may be grounds for rejection of the bid or proposal.

11. Any person doing business or seeking to do business with the City shall abide by the following Global Sullivan Principles:

- A. Support universal human rights and particularly, those of employees, the communities within which you operate, and parties with whom you do business.

- B. Promote equal opportunity for employees at all levels of the company with respect to issues such as color, race, gender, age, ethnicity, or religious beliefs, and operate without unacceptable worker treatment such as the exploitation of children, physical punishment, female abuse, involuntary servitude, or other forms of abuse.
- C. Respect employee's voluntary freedom of association.
- D. Compensate employees to enable them to meet at least their basic needs and provide the opportunity to improve their skill and capability in order to raise their social and economic opportunities.
- E. Provide a safe and healthy workplace; protect human health and the environment; and promote sustainable development.
- F. Promote fair competition including respect for intellectual and other property rights, and not offer, pay, or accept bribes.
- G. Work with governments and communities in which you do business to improve the quality of life in those communities -- their educational, cultural, economic, and social well-being -- and seek to provide training and opportunities for workers from disadvantaged backgrounds.
- H. Promote the application of these principles by those with whom you do business.

12. **Award and Execution of Contract**

- A. **Consideration of Proposals.** After the proposals are opened and read, they will be compared on the basis of the summation of the products of the approximate quantities shown in the bid schedule by the unit bid prices, unless the proposals states a different basis for comparing bids. In the event of a discrepancy between unit bid prices and extensions, the unit bid price shall govern.

Before awarding the contract, a bidder may be required to show that he/she has the ability, experience, necessary equipment, experienced personnel, and financial resources to successfully carry out the work required by the contract.

The right is reserved to reject any and/or all proposals, to waive technicalities, to advertise for new proposals, or to proceed to do the work otherwise, if in the judgement of the department the best interest of the City will be promoted thereby.

- B. **Award of Contract.** The award of the contract, if it be awarded, must be within thirty (30) calendar days after the opening of proposals to the lowest responsible and qualified bidder whose proposal complies with all the requirements prescribed. The successful bidder will be notified by letter mailed to the address shown on his proposals that his bid has been accepted and has been awarded the contract.
- C. **Cancellation of Award.** The City reserves the right to cancel the award of any contract at any time before the execution of said contract by all parties without any liability against the City.
- D. **Right to Audit.** The City Auditor or his designee shall have the right to audit the contract and any books, documents, or records relating thereto.

**Pre-Bid Meeting:** There will not be a pre-bid meeting for this contract. Questions may be submitted to [procurement@wilmingtonde.gov](mailto:procurement@wilmingtonde.gov). Relevant questions will be responded to via an addendum that will be emailed to all planholders of record. Questions will not be accepted after February 1, 2022 at 4:30 pm.



**City of Wilmington  
Delaware**

**Department of Public Works**

**Street Paving, Phase X  
Contract No. 22029PW**

**DESCRIPTION OF WORK**

The purpose of this contract is to repair sections of bituminous concrete pavement on roads in The City of Wilmington. Work includes saw-cutting, milling, paving, hot-mix patching, crack sealing, paint striping, and utility adjustments. The specific work sites are not listed herein but will be assigned as available by the City of Wilmington via work orders.

**CONTRACT TIME**

One year with the option for two (2) one (1) year extensions.



Prepared by: The Kercher Group, Inc.  
254 Chapman Road  
Suite 202  
Newark, Delaware 19702  
(302) 894-1098



City of Wilmington, Delaware  
Department of Public Works  
Street Paving, Phase X  
Contract No. 22029PW

**TABLE OF CONTENTS**

Index	i to ii
Bidding Procedures	BP-1 to BP-5
General Conditions	GC-1 to GC-19
Disadvantaged Business Program	DBE-1 to DBE- 11
Responsible Contractor Certification	RC-1 to RC-6
General Contract Plan Notes	GCPN-1 to GCPN-11
Prevailing Wage Rates for Highway Construction	PW-1
Hydrant Permit	HP-1 to HP-2
Details	DETAIL – 2 to DETAIL -4
<b>Special Provisions</b>	
401502 Asphalt Cement Cost Adjustment	SP-1
401699 Quality Control/Quality Assurance of Bituminous Concrete	SP-2 to SP-21
710507 Adjust and Repair Existing Sanitary Cleanouts	SP-22
710600 Adjusting Existing Monument Box and/or Lamp Hole	SP-23
763531 Work Order Mobilization / De-Mobilization	SP-24
801500 Maintenance of Traffic – All Inclusive	SP-25 to SP-29
817548 Thermoplastic Transverse Line, 16”	SP-30 to SP-31
905004 Inlet Sediment Control, Drainage Inlet	SP-32

City of Wilmington, Delaware  
Department of Public Works  
Street Paving, Phase X  
Contract No. 22029PW

**TABLE OF CONTENTS**

(Continued)

**Special Provisions Cont.**

905004-A Reuse, Inlet Sediment Control, Drainage Inlet	SP-32
999000 Protection of Trees	SP-33 to SP-36
Proposal Forms	PF-1 to PF-5
Consent of Surety	CS-1

---

**Bid Package**

- DBE Forms
- Responsible Contractor Forms
- Bid Proposal
- Consent of Surety

# CITY OF WILMINGTON



## GENERAL CONDITIONS FOR CONSTRUCTION CONTRACTS



## INDEX

	<u>PAGE</u>
ACCESS TO WORK.....	GC-14
ALTERATION OF PLANS OR OF CHARACTER OF WORK.....	GC-17
ANNULMENT OF CONTRACT .....	GC-8
AUTHORITY AND DUTIES OF INSPECTORS .....	GC-7
AUTHORITY OF ENGINEER .....	GC-7
AVAILABILITY OF FUNDING.....	BP-5
AWARD AND EXECUTION OF CONTRACT .....	BP-5
AWARD AS AN ENTIRETY .....	BP-4
CLAIMS TO BE MADE PROMPTLY .....	GC-11
CLEANING UP .....	GC-8
COMMENCEMENT OF WORK .....	BP-4
COMPENSATION AND LIABILITY INSURANCE .....	GC-1
CONDITIONAL ACCEPTANCE.....	GC-12
CONTRACT BOND .....	BP-4
CONTRACTOR'S EXPENSE .....	GC-13
CONTRACTOR'S RESPONSIBILITY FOR WORK .....	GC-6
COOPERATION OF CONTRACTOR AND REPRESENTATIVE .....	GC-5
DAMAGE TO UTILITIES .....	GC-6
DEFECTIVE MATERIALS AND WORK.....	GC-7
DEFINITIONS OF TERMS .....	BP-1
DELINQUENT TAXES, ETC.....	GC-18
DELIVERY AND OPENING OF PROPOSALS.....	BP-3
DIMENSIONS AND LEVELS.....	GC-18
EMPLOYEES AND EQUIPMENT.....	GC-4
ENGINEER MAY INCREASE OR DECREASE QUANTITIES .....	GC-2
ESTIMATED QUANTITIES.....	BP-1
EXECUTION OF CONTRACT.....	BP-4
EXTENSION OF TIME .....	GC-4
EXTRA WORK .....	GC-2
EXTRA WORK A PART OF THE CONTRACT.....	GC-11
FAILURE TO EXECUTE CONTRACT AND BOND.....	BP-4
FAILURE TO REMOVE AND RENEW DEFECTIVE MATERIALS AND WORK .....	GC-8
FAMILIARITY WITH LAWS, ETC.....	BP-2
FAMILIARITY WITH PROPOSED WORK.....	BP-2
FINAL ACCEPTANCE OF PAYMENT.....	GC-12
FORCE ACCOUNT WORK .....	GC-3
GUARANTEE .....	GC-14
HOURS OF LABOR .....	GC-14
INDEMNIFICATION OF THE CITY .....	GC-1
INSPECTION OF MATERIALS AND WORK.....	GC-7
INTERPRETATIONS OF ADDENDUM .....	BP-3
INTERPRETATION OF PLANS, ETC.....	GC-17
IRREGULAR PROPOSALS.....	BP-2
LAST PAYMENT TO TERMINATE LIABILITY OF THE OWNER.....	GC-13
LAWS TO BE OBSERVED.....	GC-5

	<u>PAGE</u>
LEGAL ADDRESS.....	GC-13
LIABILITY OF CONTRACTOR.....	GC-1
MAINTENANCE OF TRAFFIC.....	GC-6
MAINTENANCE, REPAIRS, ETC., AFTER COMPLETION.....	GC-18
MATERIAL SAMPLES.....	BP-4
MATERIALS AND WORK NOT PAID FOR BY THE CONTRACTOR.....	GC-9
MEASUREMENT OF QUANTITIES.....	GC-9
NIGHT, WEEKEND, AND CITY HOLIDAY WORK.....	GC-13
NO ESTOPPEL OR WAIVER OF LEGAL RIGHTS.....	GC-10
NO LIMITATION OF LIABILITY.....	GC-13
PARTIAL PAYMENT.....	GC-12
PATENTS.....	GC-2
PAYMENTS MAY BE WITHHELD.....	GC-12
PERMITS, LICENSES, CHARGES, AND NOTICES.....	GC-2
PLANS AND SPECIFICATIONS FURNISHED TO CONTRACTOR.....	GC-17
PLANS, ETC., TO BE FOLLOWED.....	GC-17
PROPOSAL FORM.....	BP-2
PROSECUTION OF WORK.....	GC-4
PUBLIC CONVENIENCE AND SAFETY.....	GC-5
QUALIFICATIONS FOR BIDDERS.....	BP-3
QUALITY OF MATERIALS AND WORKMANSHIP.....	GC-18
REMEDIES CUMULATIVE.....	GC-13
RIGHT TO REJECT BIDS.....	BP-3
SANITARY PROVISIONS.....	GC-5
SCOPE OF PAYMENT.....	GC-11
SCOPE OF WORK.....	GC-2
STORAGE OF MATERIALS.....	GC-18
STRIKES, ETC.....	GC-14
SUBCONTRACTORS.....	GC-10
SUPERVISION BY ENGINEER.....	GC-7
TEMPORARY SUSPENSION OF WORK.....	GC-8
TEST OF SAMPLES OF MATERIALS.....	GC-17
UNAUTHORIZED WORK.....	GC-4
UNRESPONSIVE OR UNBALANCED BIDS.....	BP-2
WAGES PAYABLE UNDER MUNICIPAL CONTRACTS, ETC.....	GC-15
WATER SUPPLY.....	GC-5
WITHDRAWAL OF PROPOSALS.....	BP-3

**ATTACHMENTS**

CITY OF WILMINGTON – DBE PROGRAM AND BIDDERS REQUIREMENTS Mayor’s Office of Economic Development – SMBE/DBE Office 1/2010.....	1 - 12
---	--------

# Construction Contracts

## Bidding Procedures

### DEFINITIONS OF TERMS

Whenever in these specifications and other contract documents the following terms or pronouns in place of them are used, their intent and meaning shall be interpreted as follows:

<b>"City"</b>	The City of Wilmington
<b>"Owner"</b>	The City of Wilmington
<b>"Director"</b>	The Director or Commissioner of the Department of the "City" for which the work is being done or his duly authorized representative.
<b>"Manager"</b>	The Manager, Department of Finance, Division of Procurement and Records.
<b>"Contractor"</b>	Party of the second part of the contract, acting directly or through his agents or employees.
<b>"Work"</b>	Any or all things agreed to be furnished or done by or on the part of the Contractor, and which are required in the construction and completion of the project herein contemplated, including also labor, materials and equipment.
<b>"Engineer"</b>	The City Engineer or his duly authorized representative.

All things contained or referred to herein, the Advertisement, the Instructions to Bidders, the General Conditions, the Special Provisions, the Specifications, the Proposal, the Contract, the Bond, the Plans, Addenda, as well as any other papers or bulletins referred to therein are hereby made a part of these specifications and contract, and are to be considered as one instrument constituting the "Contract Documents." The intent is to make them explanatory one or to the other but in the case of any inconsistency, the provisions of the Contract shall govern.

Whenever in these contract documents, the words "directed," "required," "prescribed," "permitted," "approved," "acceptable," "in the judgment of," and other words and phrases of like import, refer to the work or its performance, they shall be taken to mean and intend "directed," "required," "prescribed," "permitted," "approved," "acceptable," "in the judgment of," and the like by or to the Director.

The headings and subheadings printed in these specifications are intended for convenience or reference only and shall not be considered as having any particular bearing on the interpretation thereof.

### ESTIMATED QUANTITIES

Any estimates of quantities herein furnished by the Director are approximate only, and have been used by the Director as a basis of estimating the cost of the work, and will also be used for the purpose of tabulating and comparing the bids and awarding the contract. The Engineer has endeavored to estimate these quantities correctly, according to his knowledge and the information shown on the plans;

but it is not guaranteed that these estimated quantities are accurate, and if the Contractor, in making up and/or submitting his bid or bids, relies upon the accuracy of such estimated quantities, he does so at his own risk.

### **PROPOSAL FORM**

The Bidder will be furnished -- by the Manager -- with proposal forms which will show the approximate estimate of the various quantities of work to be performed and materials to be furnished under the unit and lump sum price items.

The Bidder shall submit his proposal on the forms furnished by the Manager. The blank spaces in the proposal shall be filled in correctly where indicated, for each and every item, and the Bidder shall state the prices (written in ink, in words and numerals) for which he proposes to do each item of the work contemplated. In case of discrepancy between the written figures and the numerals, the written figures shall govern.

The Bidder shall sign his proposal correctly. If the proposal is made by an **individual**, his name and post office address shall be shown. If made by a **firm or partnership**, the name and post office address of the firm or partnership, and of each member thereof, shall be shown. If a **corporation**, the successful bidder shall furnish a certificate from the Secretary of State or commonwealth where the firm is incorporated stating the company is a presently subsisting corporation of that state or commonwealth and the date of its incorporation.

Further, the successful bidder shall furnish an original and two copies of excerpts from the minutes of the corporation authorizing its President or Vice President to execute the necessary Contract on behalf of the Corporation, and an original and two copies of the resolution authorizing the Secretary or the Assistant Secretary to attest Contract Documents and the names of all officers qualified to sign for your company.

### **IRREGULAR PROPOSALS**

Proposals may be rejected if they show any omissions, alterations of form, additions not called for, conditional or alternative bides, or irregularities of any kind.

### **UNRESPONSIVE OR UNBALANCED BIDS**

To better insure fair competition, and to permit a determination of the lowest bidder, unresponsive bids or bids obviously unbalanced, may be rejected by the Manager.

### **FAMILIARITY WITH PROPOSED WORK**

The Bidder is required to examine carefully the site of the work, the proposal, the plans, specifications and other contract documents for the work contemplated and it will be assumed that he had familiarized and satisfied himself as to the conditions and obstacles to be encountered, as to the character, quality and quantities of work to be performed and materials to be furnished, and as to the requirements of these specifications, plans and other contract documents and he must be prepared to execute a finished job in every particular, without any extra charge whatever, except as may be specifically provided for elsewhere in these contract documents.

### **FAMILIARITY WITH LAWS, ETC.**

The Bidder is assumed to have made himself familiar with all Federal, State, Local, and municipal laws, ordinances, rules and regulations which in any manner affect those engaged or employed in the work, or the materials or equipment used in or upon the work, or in any way affect the work, and no plea of



misunderstanding will be considered on account of the ignorance thereof. If the Bidder or Contractor shall discover any provision in the plans, specification, or contract which is contrary to or inconsistent with any such law, ordinance, rule or regulation, he shall forthwith report it to the Engineer in writing.

### **INTERPRETATIONS OF ADDENDUM**

If any person contemplating submitting a bid for this contract is in doubt as to the true meaning of any part of the plans, specifications, or other proposed contract documents, he may submit to the Director a written request for interpretation thereof. The person submitting the request will be responsible for the prompt delivery before one week prior to the date affixed for the opening of bids. Any interpretation of the proposed contract documents will be made only by Addendum duly issued, and a copy of such Addendum will be mailed directly to each person receiving a set of such documents. The City will not be responsible for any other explanation or interpretations of the proposed documents.

### **DELIVERY AND OPENING OF PROPOSALS**

Proposals shall be submitted in triplicate with all blanks filled in. They shall be enclosed in sealed envelopes, endorsed, and delivered as stated in the Advertisement. If forwarded by mail, the above-mentioned envelope shall be enclosed in another envelope addressed to the Manager, Division of Procurement and Records, City/County Building, Wilmington, Delaware, preferably by registered mail. No responsibility shall be attached to any persons for the premature opening of any proposal not properly endorsed.

Proposals will be publicly opened and read aloud at the time and place stated in the Advertisement. Bidders or their authorized agents are invited to be present.

### **WITHDRAWAL OF PROPOSALS**

Any bid may be withdrawn prior to the scheduled time for the opening of bids or authorized postponement thereof. No bid may be withdrawn within thirty (30) days after the actual opening thereof.

### **QUALIFICATIONS FOR BIDDERS**

No contract will be awarded to any bidder who, in the judgment of the Manager, is not a responsible bidder, or is not prepared with all the necessary experience, capital, organization and equipment to conduct and complete work for which the bidder proposes to contract, in strict accordance with all terms and provisions of the contract documents.

In each instance when the qualifications of any bidder are questioned in any way, such bidder shall furnish information concerning his experience, capital, organization and equipment as may be required by the Owner within five (5) days after written notice from the Board to do so, and the information so furnished by the bidder, together with any other information received or possessed by the Owner, will be taken into consideration by the Manager in awarding the contract.

### **RIGHT TO REJECT BIDS**

The Manager expressly reserves the right to reject any or all bids, or to accept any bid, and/or to waive technicalities as he may deem to be in the best interest of the City. The successful bidder will be required to have or obtain an appropriate Business License from the Department of Finance, Earned Income Tax Division, of the City of Wilmington in order to be awarded the contract.

## **MATERIAL SAMPLES**

Before any contract is awarded, the Bidder may be required to furnish a complete statement of the origin, composition and manufacture of any and all materials to be used in the work, together with samples, which samples may be subjected to the tests provided for in these specifications to determine their quality and fitness for the work.

## **AWARD AS AN ENTIRETY**

While bids are asked for by items, the contract will not be awarded by items, but will be awarded as an entirety, on the basis of the "Bid Total," which total must be the aggregate sum of the bids on all items figured at the unit and lump sum prices bid. Bidders shall bid on all items.

## **CONTRACT BOND**

The successful bidder must furnish, within ten (10) days after the award, a Performance Bond and/or Labor and Materials for 100% of the total cost of the Contract Price, in triplicate, with corporate surety authorized to do business in the State of Delaware, the form and surety to be approved by the City Solicitor, with a Warrant of Attorney to confess judgment thereon attached thereto.

Whenever surety or sureties on the bond so furnished in accordance with the preceding paragraph shall be deemed by the Owner to be insufficient or unsatisfactory, he may, in his discretion, within ten (10) days after notice to that effect, mail to the address of the Contractor, require the Contractor to furnish and deliver a new bond in the same penalty and on the same conditions, with surety satisfactory to the Owner, and this duty shall continue on the part of the Contractor whenever and so often as the Owner shall require a new bond with a satisfactory surety or sureties. Upon failure of the Contractor to furnish the aforesaid new bond within ten (10) days after said notice is mailed to his address, the Owner may withhold all payments due to the Contractor, stop all further work under said Contract, and re-let the unfinished work at the expense of the Contractor, in any manner in which it may deem best to protect the interests of the City.

## **EXECUTION OF CONTRACT**

The successful bidder will be required promptly to execute a formal contract upon blank forms with proper insertions furnished by the Owner. Successful bidder will insert on the first page of the contract the date of the day the contract is executed by his company. All copies of the Contract and Bond must be properly executed by qualified officers of the company and the Corporate Seal affixed thereto.

## **FAILURE TO EXECUTE CONTRACT AND BOND**

Failure to enter bond in a sum equal to the full amount of the award or to execute the contract within ten (10) days after written notice of the award, shall be just cause for the annulment of the award, and it is understood by the Bidder, in the event of the annulment of the award, that the amount of the certified check with the proposal may be forfeited to the use of the City, not as a penalty, but as liquidated damages.

## **COMMENCEMENT OF WORK**

Work at the site shall be commenced within ten (10) days after the date of the contract and bond and shall be completed within the time stated in the proposal.

## **AVAILABILITY OF FUNDING**

The Contract shall be subject to the availability of funding approved by the Wilmington City Council. Contractor shall not exceed the total value of the City of Wilmington's purchase order for this Contract.

## **AWARD AND EXECUTION OF CONTRACT**

1. **Consideration of Proposals.** After the proposals are opened and read, they will be compared on the basis of the summation of the products of the approximate quantities shown in the bid schedule by the unit bid prices, unless the proposals states a different basis for comparing bids. In the event of a discrepancy between unit bid prices and extensions, the unit bid price shall govern.

Before awarding the contract, a bidder may be required to show that he/she has the ability, experience, necessary equipment, experienced personnel, and financial resources to successfully carry out the work required by the contract.

The right is reserved to reject any and/or all proposals, to waive technicalities, to advertise for new proposals, or to proceed to do the work otherwise, if in the judgment of the department, the best interest of the City will be promoted thereby.

2. **Award of Contract.** The award of contract, if it be awarded, must be within thirty (30) calendar days after the opening of proposals to the lowest responsible and qualified bidder whose proposal complies with all the requirements prescribed. The successful bidder will be notified by letter mailed to the address shown on his proposal that his bid has been accepted and has been awarded the contract.
3. **Cancellation of Award.** The City reserves the right to cancel the award of any contract at any time before the execution of said contract by all parties without any liability against the City.



# **Construction Contracts**

## **General Conditions**

### **COMPENSATION AND LIABILITY INSURANCE**

Except as otherwise provided by law, the Contractor shall, at all times, maintain and keep in force such insurance as will protect him from claims under workmen's compensation acts, also such insurance will protect him and the City from any other claims for damages for personal injuries, including death, which may arise from operations under this contract, whether such operations be by the Contractor or by any subcontractor or anyone directly or indirectly employed by any of them, in any amount specified by the Chief Engineer of the Department of Public Works. The Contractor shall also, at all times, maintain and keep in force such insurance, in an amount specified by the Chief Engineer of the Department of Public Works, as will protect him and the City, its agents and employees from all suits, actions, claims, demands, damages, losses, expenses, and/or costs of every kind and description to which the City may be subjected or put by reason of injury (including death) to persons or property resulting from the manner or method employed by the Contractor, his agents and employees, or subcontractors, or from any neglect or default of the Contractor, his agents, employees, or subcontractors, in the performance of this contract, or any part thereof, or from, by, or on account of any act or omission of the Contractor, his agents and employees, or subcontractors, and whether such suits, claims, actions, demands, damages, losses, expenses, and/or costs be against, suffered, or sustained by other corporations and persons to whom the City, its agents and employees, may become liable therefor.

### **LIABILITY OF CONTRACTOR**

Whenever the Contractor is required by the existing State, Federal, local or municipal law, ordinance, rules or regulations, or by any State, Federal, local, or municipal laws, ordinances, rules or regulations that may be enacted hereafter pertaining to the work to be done under this contract, to secure any permits or licenses to carry on any operation or operations in connection with the performance of the contract and/or to act under the direction or supervision of a City official and/or employee in connection with any such operation or operations, the Contractor shall be solely liable for all suits, actions, costs and damages of every kind and description resulting or which may result, directly or indirectly, from any such operation or operations and shall indemnify and save harmless the City from any and all suits, actions, costs, and damages of every kind and description arising or which may arise, directly or indirectly from the said operation or operations.

### **INDEMNIFICATION OF THE CITY**

The contractor shall pay, indemnify, and save harmless the City, its agents and employees from all suits, actions, claims, demands, damages, losses, expenses, and/or costs of every kind and description to which the City may be subjected or put by reason of injury (including death) to persons or property resulting from the manner or method employed by the Contractor, his agents and employees, or subcontractors, or from neglect or default of the Contractor, his agents and employees or subcontractors in the performance of this contract or any part thereof or from, by, or on account of any act or omission of the Contractor, his agents and employees, or subcontractors, and whether such suits, actions, claims, demands, losses, expenses, and/or costs against, suffered, or sustained by the City, his agents and employees, may become liable therefor, and the whole, or so much of the monies due, or become due the Contractor under this contract or any other contract as may be considered necessary by the Engineer may be retained by the City until such suits or claims for damages shall have been settled or otherwise disposed of the satisfactory evidence to that effect furnished to the Engineer.

## **PATENTS**

Whenever any article, material, mean, appliance, process, composition, combination, or thing called for by these specifications is covered by Letters Patent, the successful bidder must secure, before using or employing such article, material, mean, appliance, process, composition, combination, or thing, the assent, in writing, of the Owner or Licensee of such Letter Patent and file the same with the Engineer.

The said assent is to cover not only the use, employment, and incorporation of said articles, materials, means, appliances, processes, compositions, combinations, or things in construction and completion of the work, but also the permanent use of said articles, materials, means, appliances, processes, compositions, combinations, or things, thereafter, by or on behalf of the City in the operation and maintenance of the project for the purpose for which it is intended or adapted.

The Contractor shall be responsible for any claims made against the City or any of its agents and employees for any actual or alleged infringement of patents by the use of patented articles, materials, means, appliances, processes, compositions, combinations, or things, in the construction, completion, and the use of the work, and shall save harmless and indemnify the City and its agents and the employees' fees which the City may be obliged to pay by reason of any actual or alleged infringement of Patents used in the construction, completion, maintenance, operation of the work and projects herein specified.

## **SCOPE OF WORK**

The work to be done under these specifications is to cover the completed work shown on the plans or called for in the specifications and other contract documents. The Contractor shall furnish all implements, machinery, tools, equipment, materials, and labor necessary to the performance of the work and shall furnish and do everything necessary to make the work perfect, complete, neat, and finished, and the Contractor shall leave all the work to be done under this contract in this condition at the time the work is finally inspected.

## **PERMITS, LICENSES, CHARGES, AND NOTICES**

The Contractor shall procure all permits and licenses, pay all royalties, charges, and fees, and give all notices necessary and incident to the due and lawful prosecution of the work.

## **ENGINEER MAY INCREASE OR DECREASE QUANTITIES**

The Engineer reserves the right to increase or diminish the amount of quantity of any unit price item included in the Bid or Proposal, wherever he deems it advisable or necessary so to do, and such increase or diminution shall in no way vitiate the contract.

The Contractor shall be paid for the actual amount of quantity of authorized work done or materials furnished under the unit price item of the "Bid or Proposal" at the price bid stipulated for such item. In case the amount of quantity of any item is increased as above provided, the Contractor shall not be entitled to any damages, or increased compensation over and above the price bid for such item, and in case the amount of quantity of any item is diminished as above, provided, the Contractor shall not have any claim for damages on account of loss of anticipated profits or otherwise, because of such diminution.

## **EXTRA WORK**

The Contractor shall perform extra work, for which there is no quantity and price, included in the contract, whenever, to complete fully the work contemplated, it is deemed necessary or desirable, by written authority of the Engineer, and such extra work shall be done in accordance with the

specifications therefore, or in the best workmanlike manner as directed. This extra work will be paid for at a unit price or lump sum to be agreed upon previously, in writing, by the Contractor and the Engineer, or where such a price or sum cannot be agreed upon by both parties, or where this method of payment is impracticable, the Engineer may order the Contractor to do such work on a "force account" basis.

### **FORCE ACCOUNT WORK**

All extra work done on a "force account" basis will be paid for in the following manner:

1. For all labor and foremen in direct charge of the specific operation, the Contractor shall receive the rates of wage applicable to this contract, for each and every hour that said labor and foreman are actually engaged in such work.
2. For all material used, the Contractor shall receive the actual cost of such materials, as shown by original receipted bills.
3. An additional amount of twenty-five percent (25%) of the total cost of labor and materials of 1 and 2 above shall be added to allow for profit and overhead of subcontractors and a Contractor.
4. For any machine-power tools or equipment and for any hauling equipment, including fuel and lubricants, which it may be deemed necessary or desirable to use, the Engineer shall allow the Contractor a reasonable rental price, to be agreed upon in writing before such work is begun, for each and every hour that said tools or equipment are in use or on such work, and to its sum no percentage shall be added.

The compensation as herein provided shall be received by the Contractor as payment in full for extra work done on a "force account" basis, and shall include superintendents, use of tools and equipment to which no rental is allowed, and profit. The Contractor's representative and the Inspector shall compare records of extra work on a "force account" basis at the end of each day. Copies of these records shall be made in duplicate, upon the Engineer's "force account" forms provided for this purpose by the Inspector and signed by both the Inspector and the Contractor's representative, one copy being forwarded respectively to the Engineer and to the Contractor. All claims for extra work done on a "force account" basis shall be submitted to the Engineer by the Contractor upon certified triplicate statements, which shall also include the value of all material used in such work, and following that in which the work was actually performed and shall include all labor charges, etc., and material charges insofar as they can be verified.

Should the Contractor refuse or fail to prosecute the work as directed or submit his claim as required, the Engineer may withhold payment of all current estimates until the Contractor's refusal or failure is eliminated, or after giving the Contractor due notice, the Engineer may make payment for said work on the basis of reasonable estimate of the value of the work performed.

On extra work as defined in this paragraph, the Contractor will be reimbursed for his expenditures for Workmen's Compensation Insurance, Social Security taxes, and Unemployment Compensation covering the men actually engaged upon such work. No percentage will be added to such payments, but the Contractor shall be entitled to receive only the actual amount of money expended for such Workmen's Compensation Insurance, Public Liability Insurance, Social Security taxes, and Unemployment Compensation. Such payments shall be based upon the prevailing standard insurance

rates support by receipted vouchers from the insurance vendors and upon the actual amount of taxes paid for Social Security and Unemployment Compensation as evidenced by proper documents furnished by the Contractor.

### **EXTENSION OF TIME**

Should the Contractor allege to be delayed in the completion of the work by the act, neglect, or default of the Owner, Engineer or any other contractor employed by the Owner under the work, or by damage, caused by fire, flood, or other casualty for which the Contractor is not responsible, he may petition that the time fixed for completion of the work will be extended for a period equivalent to the time lost by any or all that causes aforesaid, which extended period shall be determined and fixed by the Engineer, but no such allowance will be made unless a claim therefore is presented in writing to the Engineer within five (5) days of the occurrence of such delay, and then only when granted in writing with the signature of the Engineer.

### **UNAUTHORIZED WORK**

Work done beyond the lines and grades shown on the plans or as given, except as herein provided, or any extra work done without written authority, will be considered as unauthorized and at the expense of the Contractor and will not be measured by the Engineer or paid for by the City. Work so done may be ordered removed and replaced by the Engineer at the Contractor's expense.

### **PROSECUTION OF WORK**

The Contractor shall begin work to be performed under the contract within ten (10) days after the date of the contract. The place where the work is to be started will be designated on the ground by the Engineer. The work shall be prosecuted from as many different points, in such part or parts and at such time as may be directed, and shall be conducted in such a manner and with sufficient materials, equipment, and labor as is considered necessary to insure its completion within the time set forth in the contract.

Should the prosecution of the work for any reason be discontinued by the Contractor with the consent of the Engineer, he shall notify the Engineer at least twenty-four (24) hours before again resuming operations.

### **EMPLOYEES AND EQUIPMENT**

Any employees of, or person connected with the Contractor, who shall use profane or abusive language to the Inspector, or other employees of the City, or otherwise interfere with him in the performance of his duties, or shall disobey or evade his instructions, or who is careless or incompetent, or is objectionable to the City authorities, shall be discharged on the request of the Engineer, and shall not again be employed without his consent.

The Contractor shall furnish such equipment as is considered necessary by the Engineer for the prosecution of the work in an acceptable manner and at a satisfactory rate of progress. Equipment used on any portion of the work shall be such that no injury to adjacent work or property will result from its use.



## **COOPERATION OF CONTRACTOR AND REPRESENTATIVE**

The Contractor shall give the work his constant attention to facilitate the progress thereof and shall cooperate with the Engineer in every way possible. The Contractor shall have at all times competent and reliable English-speaking representatives on work, authorized to receive orders and act for him.

## **LAWS TO BE OBSERVED**

The Contractor at all times shall observe and comply with all Federal, State, local and municipal laws, ordinances, rules, and regulations in any manner effecting the work, and all such orders or decrees as exist at present and those which may be enacted later, of bodies or tribunals having any jurisdiction or authority over the work, and shall indemnify and save harmless the City and all its officers, agents, and servants against any claim or liability arising from or based on the violation of any such law, ordinance, regulation, rule, order, or decree, whether such violations be by the Contractor, or any subcontractor, or any of their agents, and/or employees.

## **SANITARY PROVISIONS**

The Contractor shall provide and maintain a neat sanitary condition, such sanitary conveniences and accommodations for the use of his employees as may be necessary to comply with the requirements and regulations of the Department of Health or of other bodies or tribunals having jurisdiction thereof. He shall commit no public nuisance.

## **WATER SUPPLY**

Where water directly from the City-owned water mains is available, it will be supplied to the Contractor upon request and approval, at regular meter and/or rental rates, at the nearest available hydrant or outlet, and no other water shall be used for any purposes connected with the contract, except by permission of the Engineer.

The Contractor will be required to provide approved, standard tight hose, and fittings with which to make connection to hydrants and outlets. No improper, wasteful, or undue use of water will be permitted.

The Contractor shall procure from the Water Department a regular wrench for use on hydrants and no other wrench shall be used. He shall conform to all the rules and regulations of the Water Department in connection with the use of water hydrants, pipes, etc.

Where water directly from the City-owned water mains is not available, the Contractor shall, at his own cost and expense, provide such quantities of clean water as may be required for any and all purposes under the contract. He shall supply sufficient drinking water to allow his employees, but only from such sources as are approved by the Engineer and no other water shall be used for drinking purposes.

## **PUBLIC CONVENIENCE AND SAFETY**

The Contractor at all times shall conduct the work in such a manner as to insure the least obstruction to traffic practicable. The convenience of the general public and of the residents and occupants or property along and adjacent to the work shall be provided for in an adequate and satisfactory manner. Materials stored upon highway shall be placed so as to cause as little obstruction to the traveling public as is considered necessary. Fire hydrants on or adjacent to the work shall be kept accessible to fire apparatus at all times, and no material or obstruction shall be placed within fifteen (15) feet of any such hydrant. Footways and portions of highways and streams adjoining the work under construction shall not be obstructed more than is absolutely necessary. All gutters and sewer inlets shall be kept

unobstructed at all times. In no case, shall any traveled thoroughfare be closed without permission of the Engineer.

### **MAINTENANCE OF TRAFFIC**

The Contractor shall submit a maintenance of traffic plan for approval by the Engineer seven (7) days prior to start of work. The maintenance of traffic plan shall contain only approved traffic control devices and methods of operation in accordance with the State of Delaware "Manual on Traffic Control for Street/Highway Construction and Maintenance Operations." The Contractor shall not perform any work until the maintenance of traffic plan has been approved in writing by the Engineer.

The Contractor shall not enter upon private property for any purpose without obtaining permission, and shall be responsible for the preservation of all public and private property, trees, monuments, etc., along and adjacent to the work and shall use every precaution necessary to prevent damage or injury to property or persons. He shall use suitable precautions to prevent damage to pipes, conduits, and other underground structures and shall protect carefully from disturbances or damage of all and monuments and property marks until an authorized agent has witnessed or otherwise referenced their location, and shall not remove them until directed. The Contractor shall not willfully nor maliciously injure or destroy trees or shrubs and shall not remove or cut them without proper authority. He shall be strictly responsible for any and all damage or injury of every kind and description, which directly or indirectly may be done to any property or sustained by any persons during the prosecution of the work resulting from any wrongdoing, misconduct, want of skill, or any negligence of himself or his agents and/or employees, or at any time due to defective work or materials. Where or when any direct or indirect damage or injury is done to public or private property by or on account of any act, omission, neglect, or misconduct in the execution of the work or in consequence of the non-execution thereof on part of the Contractor, he shall restore, at his own expense, such property to a condition similar or equal to that existing before such damage or injury was done by repairing, rebuilding, or otherwise restoring as may be directed, or he shall make good such damage or injury in an acceptable manner. In case of the failure on the part of the Contractor to restore such property, or make good such damage or injury, the Engineer may, upon three (3) days notice, proceed to repair, rebuild, or otherwise restore such property as may be deemed necessary, and the cost thereof may be deducted from any monies due or which may become due to the Contractor under this contract.

### **DAMAGE TO UTILITIES**

Should the Contractor or his workmen in the execution of this contract cause damage to any underground construction, such as water, telephone, electric, and police conduit, such damage shall be repaired or replaced by the Contractor at his own expense and under the direction of the Engineer; or such repairs to the damaged utility or utilities may be made by employees of the respective utility company or companies whose underground structure was damaged by the Contractor or his workmen and such costs for these repairs shall be paid by the Contractor.

### **CONTRACTOR'S RESPONSIBILITY FOR WORK**

Until the final acceptance of all work, as indicated in writing by the Engineer, it shall be under the charge of and care of the Contractor and he shall take every precaution against the destruction, injury or damage to the work or to any part thereof by the action of the elements or from any other cause whatsoever. The Contractor shall rebuild, repair, restore, and make good, at his own expense, all destruction of, injuries or damages to the work, or any portion thereof, occasioned by any of the above causes before its final completion and acceptance as indicated in writing by the Engineer.

### **SUPERVISION BY ENGINEER**

The work is to be carried out under the supervision of the Engineer to his entire satisfaction. The work and materials shall be strictly of the best quality of the kinds specified herein, and should any work or materials other than those specified as shown be introduced into the construction of the work, the Engineer, or his authorized agent, shall have full power to reject them, and they shall be removed from the premises in three (3) days by the Contractor after being notified to do so.

### **AUTHORITY OF ENGINEER**

The Engineer shall in all cases determine the amount of quantity, quality, acceptability of the work and materials which are to be paid for under this contract and shall decide all questions in relation to said work and the performance thereof; and shall, in all cases, decide questions which may arise relative to the fulfillment of the contract to the obligations of the Contractor thereunder.

### **AUTHORITY AND DUTIES OF INSPECTORS**

Inspectors employed by the Owner shall be authorized to inspect all work done and materials furnished. Such inspection may extend to all or part of the work to the preparation or manufacture of the materials to be used. An inspector will be stationed on the work to report to the Engineer as to the progress of the work and the manner in which it is being performed; also to report whenever it appears that the materials furnished and the work performed by the Contractor fail to fulfill the requirements of the specifications and contract, and to call to the attention of the Contractor any such failure or other default, but no inspection, nor any failure to inspect, at any time or place, however, shall relieve the Contractor from any obligation to perform all of the work strictly in accordance with the requirements of the specifications. In case of any dispute arising between the Contractor and the Inspector as to materials furnished or the manner of performing the work, the Inspector shall perform such other duties as are assigned to him. He shall not be authorized to revoke, alter, enlarge, relax, or release any requirements of these specifications, not to approve or accept any portion of the work, nor interfere with the management of the work by the Contractor. Any instructions which the Inspector may give the Contractor shall in no way be construed as binding by the Engineer or the City in any way, nor releasing the Contractor from the fulfillment of the terms of the contract.

### **INSPECTION OF MATERIALS AND WORK**

The Contractor shall furnish the Engineer with every reasonable facility for ascertaining whether or not the work as performed is in accordance with the requirements and intent of the specifications and contract. If the Engineer requests it, the Contractor, at any time before acceptance of the work, shall remove and/or uncover such portions of the finished work as may be directed. After examination, the Contractor shall restore said portions of the work to the standards required by the specifications. Should the work thus exposed or examined prove acceptable, the uncovering, removing, replacing the covering, and/or making good the parts removed shall be paid for as "Extra Work," but should the work exposed or examined prove unacceptable, either in whole or in part, the uncovering, removing, replacing of the covering and/or making good of the parts removed, shall be at the Contractor's expense.

### **DEFECTIVE MATERIALS AND WORK**

All materials not conforming to the requirements of these specifications shall be considered defective, and all such materials, whether in place or not, shall be rejected and shall be removed immediately from the work unless otherwise permitted. No material which has been rejected, the defects of which have been corrected or removed, shall be used until approval has been given. All work which has been rejected or condemned shall be remedied, or if necessary, removed and replaced in an acceptable manner by the Contractor at his own expense.

## **FAILURE TO REMOVE AND RENEW DEFECTIVE MATERIALS AND WORK**

Should the Contractor fail or refuse to remove and renew any defective materials used or work performed previously, or to make any necessary repairs in an acceptable manner, and in accordance with the requirements of these specifications, within the time indicated in writing, the Engineer shall have the authority to cause the unacceptable or defective materials or work to be removed and renewed for such repair to be made at the Contractor's expense. Any expense incurred by the City in making these removals, renewals, or repairs, which the Contractor has failed or refused to make, shall be paid out of the monies due or which are to become due to the Contractor, or may be charged against the "Contract Bond" deposited; and continued failure or refusal on the part of the Contractor to make any or all necessary repairs, removals and renewals, promptly, fully, and in an acceptable manner shall be sufficient cause for the City to declare the contract forfeited, in which case, the City at its option may be required to perform the work, or may contract with any other individual, firm, or corporation to perform the work. All costs and expenses incurred thereby shall be charged against the defaulting contractor, and the amount thereof deducted from any monies due or to become due him and/or shall be charged against the "Contract Bond" deposited. The performance of any work by the City and/or others as specified shall not relieve the contractor in any way from his responsibilities under this contract.

## **CLEANING UP**

The Contractor shall at his own expense, keep the sites of his operations clean during the construction and remove all rubbish as it accumulates.

Upon failure of the Contractor to keep sites of his operation clean to the satisfaction of the Engineer, the City may upon twenty-four (24) hours notice to the Contractor, remove any rubbish, materials, earth, etc., which the Engineer may deem necessary, charging the cost thereof to the Contractor and may deduct the amount from any monies that may be due him. On or before the completion of the work, the Contractor shall, without charge therefore, tear down and remove all his buildings and temporary structures built by him, shall remove all rubbish of all kinds from any grounds which he has occupied, and shall leave the site of the work in a clean and neat condition.

## **TEMPORARY SUSPENSION OF WORK**

The Engineer shall have the authority to suspend the work, wholly or in part, for such a period or periods as he may deem necessary, due to unsuitable weather, or such other conditions as are considered unfavorable for the suitable prosecution of the work, or for such time as is necessarily due to the failure on the part of the Contractor to carry out orders given or perform any or all provisions of the contract. If it should become necessary to stop work for an indefinite period, the Contractor shall store all materials in such a manner that they will not obstruct or impede the traveling public unnecessarily, nor become damaged in any way, and he shall take every precaution to prevent destruction, damage, or deterioration of the work performed to provide suitable roof drainage, and erect temporary cover where necessary. The Contractor shall not suspend the work without authority. Neither the failure of the Engineer to notify the Contractor to suspend work on account of bad weather, or other unfavorable conditions, nor permission by the Engineer to continue work during bad weather or other unfavorable conditions, shall be a cause for the acceptance of any work which does not comply in every respect with the contract and specifications.

## **ANNULMENT OF CONTRACT**

If the Contractor fails to begin the work under the contract within the time specified, or fails to perform the work with sufficient materials to insure proper completion of said work, except in cases for which an extension of time is provided, or shall perform the work unsuitably or neglect or refuse to promptly remove materials or again promptly perform such work as shall be rejected as defective or of unsuitable

or shall discontinue the prosecution of the work, or if the Contractor becomes insolvent or to be declared bankrupt, or commit any act of bankruptcy or insolvency, or allow any final judgment to stand against him unsatisfied for a period of forty-eight (48) hours or shall make an assignment for the benefit of creditors or shall fail to make prompt payment for all subcontractors and/or material, for material and/or labor supplied, or shall persistently disregard any State, Federal, local or municipal laws, ordinances, rules, or regulations pertaining to the work or shall disregard the instructions of the Engineer, or from any other cause whatsoever shall not carry on the work in an acceptable manner, the Engineer may give notice in writing, mailed to the Contractor and/or Surety of such delay, neglect, default, specifying same, and if the Contractor within the period of three (3) days after such written notice is mailed, shall not proceed in accordance with same, then the City shall upon written certificate from the Engineer of the fact such delay, neglect, or default, and the Contractor's failure to comply with such notice, have full power and authority without prejudice to any of its other rights or remedies and without violating the contract, to terminate the employment of said Contractor and to take prosecution of the work out of the hands of said Contractor and to take possession of the premises and to appropriate the use of any or all materials, appliances, and equipment on the premises, and may enter into an agreement for the completion of said contract according to the terms and provisions thereof, or use such other methods as in its opinion, shall be deemed expedient and necessary for the completion of said contract in accordance with the plans and specifications, and within such time as in the judgment of the City, the public interests may require. In the event of any of the aforementioned circumstances arising at any time or times, the City shall have the right to withhold, without the payment of interest, any sum or sums of money due or to become due the Contractor until the interests of the City have been fully protected to the satisfaction of the Engineer. All costs and expenses incurred by the City together with the cost of completing the work under the contract, including the cost of additional managerial and administrative services, if any, shall be deducted from the monies due or which may become due said Contractor. In the case of expense so incurred by the City shall be less than the sum which would have been payable under the contract if it had been completed by said Contractor, then the said Contractor shall be entitled to receive the difference; and in case such expense shall exceed the sum which would have been payable under the contract, Contractor and/or Surety shall be liable therefor, and shall pay the amount of the differences to the City within ten (10) days after written notices mailed to the Contractor and/or Surety. The expense, loss, or damage, including the cost of additional managerial and administrative services, if any, incurred by the City through the Contractor's default shall be certified by the Engineer, and such certification shall be conclusive and recognized and accepted as the correct amount of the loss sustained by the City and all parties concerned.

### **MEASUREMENT OF QUANTITIES**

All work completed under the contract shall be measured by the Engineer according to the United States Standards of Measures.

### **MATERIALS AND WORK NOT PAID FOR BY THE CONTRACTOR**

When written notice is given to the Engineer before or within ten (10) days after the completion and conditional acceptance of the entire work under the contract by persons having done work or furnished materials for such contract that there is money due and unpaid for said work and materials, the Contractor shall furnish the Engineer with satisfactory evidence that said money has been fully paid for satisfactorily secured by him. In case such evidence is not furnished as aforesaid, such amounts as may be necessary to meet the claims of the persons or aforesaid may be retained from any monies due the Contractor under the contract until the liabilities aforesaid shall be fully discharged or such notices withdrawn. The City or the Engineer may also, with the written consent of the Contractor, use any money retained, due or become due under the contract, for the purpose of paying for both labor and materials for the work, for which claims have been filed in the office of the Engineer.

## **NO ESTOPPEL OR WAIVER OF LEGAL RIGHTS**

The City, or the Engineer, shall not be precluded or estopped by any measurement, estimate, or certificate made or given by them, or by any agent or employee of the City, under any provision or provisions of the contract, at any time, either before or after the completion and acceptance of the work and payment therefor, pursuant to any measurement, estimate or certificate from showing the true and correct amount and character of the work performed and materials furnished by the Contractor or from showing at any time that any such measurement, estimate, or certificate is untrue or incorrectly made in any particular, or that the work or materials or any part thereof, do not conform in fact to specifications and contract, and the Engineer shall have the right to reject the whole or any part of the aforesaid work or materials, should the said measurement, estimate, or certificate or payment be found or be known to be inconsistent with the terms of the contract, or otherwise improperly given, the City shall not be precluded and estopped, notwithstanding any such measurement, estimate, certificate, and payment in accordance therewith from demanding and recovering from the Contractor and his Surety such damages as it may sustain by reason of his failure to comply with terms of the specifications and contract. Either the acceptance by the City, the Engineer, or any agent or employee of the City, nor any certificate by the City for payment of money, nor any payment for, nor acceptance or use of, the whole or any part of the work, by the City or the Engineer, nor any extension of time, nor any possession taken by the City or its employees, shall operate as a waiver of any portion of the contract, or of any power herein reserved by the City, or any right to damages herein provided, nor shall any waiver of any breach of the contract be held to be a waiver of any other or subsequent breach.

## **SUBCONTRACTORS**

The Contractor shall give his personal attention to the faithful performance of the work, shall keep the same under his control, and shall not assign the contract by power of attorney or otherwise, nor sublet the work or any part thereof, without the previous written consent of the Engineer; he shall state to the Engineer in writing the name of each subcontractor he intends employing, the portion of work which he is to do or the materials which he is to furnish, his place of business and such other information as the Engineer may require, in order to know whether or not said subcontractors are reputable and reliable and able to perform the work or to furnish the materials as called for in the specifications. No subcontractor shall be engaged upon any branch of the work who is not thoroughly practical and responsible and at the time of making this contract, conducting business in the particular branch or trade for which he is employed.

The Contractor shall not, either legally or equitably, assign any of the monies payable under the contract, or his claims thereto, unless by and with the consent of the Engineer.

The Contractor shall not be released from any of his liabilities or obligations under this contract should any subcontractor or subcontractors fail to perform in the satisfactory manner the work undertaken by him or them.

The Contractor agrees that he is fully responsible to the City for the acts or omissions of his subcontractor, and of persons either directly or indirectly employed by them, as he is for the acts or omissions of persons directly or indirectly employed by him.

Subcontracts, if any, shall be let promptly after the signing of the contract.

Nothing contained in the contract shall create any contractual relation between any subcontractor and the City.

The Contractor shall furnish the City with a written list of all subcontractors, if any, to be used in connection with this contract. The City reserves the right to reject the use of any subcontractors for any reason whatsoever.

### **CLAIMS TO BE MADE PROMPTLY**

Should the Contractor be of the opinion, at any time or at times, that he is entitled to any additional compensation whatsoever (over and above the compensation stipulated in these contract documents or for quantities and/or amounts over and above the quantities and/or amounts allowed or approved by the Engineer), the damages, losses, costs, and/or expenses alleged to have been sustained, suffered, or incurred by him in connection with the project herein contemplated, he shall, in each instance, within five (5) days after such alleged damages, losses, costs, and/or expenses shall have been sustained, suffered, or incurred, make a written claim therefor to the Engineer. On or before the fifteenth (15th) day of the calendar month succeeding that in which such damages, losses, costs, and/or expenses shall have been sustained, suffered, or incurred, the Contractor shall file with the Engineer a written, itemized statement of the detailed amounts of each such claim or damage, loss, cost, and/or expense and unless such claim for such additional compensation shall be held and taken to be absolutely invalidated, and he shall not be entitled to any compensation on the account of each such alleged damage, loss, cost, and/or expense.

The provisions of this section shall be held and taken to constitute a condition precedent to the right of the Contractor to recover; they shall also apply to all claims by the Contractor in any way relating to the complete project; and even though the claims and/or work involved may be regarded as "outside the contract."

It is understood and agreed, however, that nothing in this section contained shall be held or taken to enlarge in any way the rights of the Contractor or the obligations of the City under these contract documents.

### **EXTRA WORK A PART OF THE CONTRACT**

No order for extra work nor the doing of any extra work, at any time or place, shall in any manner or to any extent relieve the Contractor or the Surety of his bond from any of their obligations under the contract documents; all extra work orders being given and all extra work being done, under, and in accordance with the contract are to be considered a part of the same and subject to each and every one of the terms and requirements of the contract documents, and fully covered by the bond and furnished by the Contractor.

### **SCOPE OF PAYMENT**

The Contractor shall receive and accept the compensation, as provided in the Bid or Proposal, in full payment for furnishing all materials, labor, tools, and equipment and for performing all work contemplated and embraced under the contract. Also for all loss of damages arising out of the nature of the work, or from the action of the element or from any unforeseen difficulties or obstructions, which may arise or be encountered during the prosecution of the work, until its final acceptance by the City, and for risks of every description connected with the prosecution of the work, until its final acceptance by the City, and for all risks of every description connected with the prosecution of the work, also for all expenses incurred by, or in consequence of the suspension or discontinuance of the prosecution of the work as herein specified, and for any actual or alleged infringement of patent, trade name, or copyright and for completing the work and the whole thereof, in an acceptable manner according to the plans and specifications. The payment of any current or final estimate, or of any retained percentage, shall in no way or in a degree, prejudice, or affect the obligations of the Contractor, at his own cost and expense, to renew or replace any defects and imperfections in the construction of the work or in the strength of the quality of materials used in or about the construction of the work under contract and its

appurtenances, as well as all damages due or attributable to such defects, which defects, imperfections, or damages shall be discovered on or before the final inspection and acceptance of the work, and of which defects, imperfections, or damages, the Engineer shall be the judge, and the said Contractor shall be liable to the City for failure so to do.

### **PARTIAL PAYMENTS**

The Engineer will make current estimates in writing, once each month, of the materials in place complete, and the amount of work performed in accordance with the contract, during the preceding month or period, and the value thereof figured at the unit prices of the contract, and in case of lump sum items, figured on the basis of the schedule of values to be agreed upon, as therein after provided for.

For the total of the amounts so ascertained will be deducted an amount equivalent to ten percent (10%) of the whole to be retained by the City until after the completion of the entire contract, in an acceptable manner, and the balance or sum equivalent to ninety percent (90%) of the whole, shall be paid to the Contractor by the City.

Schedule of values of the various parts of work to be done under lump sum items shall be agreed upon by the Contractor and the Engineer, and such schedules shall be the basis for determining the amount allowed the Contractor on account of such lump sum items, partial estimates, or payment under the contract.

### **PAYMENTS MAY BE WITHHELD**

Payments may at any time be withheld if the work is not proceeding in accordance with the contract, or if, in the judgment of the Engineer, the Contractor is not complying with requirements of the contract documents.

### **CONDITIONAL ACCEPTANCE**

Whenever, in the opinion of the Engineer, the Contractor shall have completed the work in an acceptable manner in accordance with the terms of the contract, the Engineer shall make an inspection of the entire work, and upon inspection and acceptance, completion of all repairs and renewals which may appear at the time to be necessary, in the judgment of the Engineer, he shall certify to the owner in writing as to said completion, and as to the value thereof. The aforesaid certificate shall be held and taken to evidence the conditional acceptance of the entire work by the Owner as of the date thereof, and an additional five percent (5%) of the whole value of the work over and above any and all other reservations and/or deductions which the City is, by the terms of the contract documents or otherwise, entitled or required to make and obtain and shall hold said five percent (5%) for a period of three (3) months from and after the date of such certificate and conditional acceptance, and the City shall be authorized to apply the whole or any part of said five percent (5%) so retained to any and all costs of repairs and renewals of the work and appurtenances which may become necessary, in the judgment of the Engineer, during such period of three (3) months on account of any failure or defects in said work and appurtenances due to improper work done or materials furnished by the Contractor, if the Contractor shall fail to make such repairs or renewals within three (3) days after receiving notice from the City to do so.

### **FINAL ACCEPTANCE OF PAYMENT**

Upon the expiration of the aforesaid three (3) months from and after the date of certificate of conditional acceptance of the work, the Engineer shall make final inspection of the entire work, and upon confirmation of all repairs and renewals which may appear at that time to be necessary in the judgment of the Engineer, he shall certify to the Owner in writing as to the final acceptance of the entire project.



The Owner, upon receipt and approval of said certificate, shall pay, or cause to be paid under the contract, except such sums which have already been paid and except such sum or sums as may have been expended by the Owner under the provisions of the contract documents and less any other deductions the Owners may be otherwise entitled to make.

The last mentioned certificate issued by the Engineer shall be deemed and accepted by all of the parties hereto as evidencing the final completion and acceptance of the entire project, and the payment made by the Owner to the Contractor pursuant to the issuance of said certificate of final completion and acceptance shall be deemed to be accepted by all of the parties hereto as the final payment to be made by the Owner to the Contractor, all prior certificates or estimates upon which payments may have been made being partial estimates and subject to correction in said final payment.

### **LAST PAYMENT TO TERMINATE LIABILITY OF THE OWNER**

The acceptance by the Contractor of the final payment shall operate as and be a release of the Owner and every agent thereof from all claims and liabilities to the Contractor for anything done or furnished or relating to the work, or for any act or neglect of the Owner or any persons relating to or affecting this work.

### **NO LIMITATION OF LIABILITY**

It is understood and agreed that any and all duties, liabilities, and/or obligations imposed upon or assumed by the Contractor and the Surety, or either of them by or under the contract documents, shall be taken and construed to be cumulative, and that the mention of any specific duty, liability, or obligation imposed upon or assumed by the Contractor and/or Surety under the contract documents shall not be taken or construed as a limitation or restriction upon any or all of the other duties, liabilities and/or obligations imposed upon or assumed by the Contractor and/or Surety by or under the contract documents.

### **REMEDIES CUMULATIVE**

All remedies provided in the contract documents shall be taken and construed to be cumulative; that is, in addition to any and all other remedies provided therein and to any remedies in law or equity which the City would have in any case.

### **LEGAL ADDRESS**

The address given in the bid or proposal is hereby designated as the legal address of the Contractor. Such address may be changed at any time by notice in writing delivered to the Engineer. The delivering of such legal address or the depositing in any post office, in a postpaid, registered wrapper direct to the above-mentioned address of any notice, letter, other communication to the Contractor, shall be deemed to be a legal and sufficient service thereof upon the Contractor.

### **CONTRACTOR'S EXPENSE**

All things required by the contract documents to be done, furnished, and/or installed shall be done, furnished and/or installed by the Contractor at his entire cost and expense, unless otherwise provided therein.

### **NIGHT, WEEKEND, AND CITY HOLIDAY WORK**

No night work between the hours of 5:00 p.m. and 8:00 a.m., no work on Saturday, Sunday, and no work on any City Holiday shall be permitted except with written permission of the Engineer. If the Contractor decides to work on those above days, he shall reimburse the City for the salaries and wages

of the City Construction Inspectors. Compensation shall include direct payroll cost and fringe benefits. The Contractor shall notify the Engineer in writing at least two (2) days in advance of such days he desires to work.

### **STRIKES, ETC.**

The Contractor shall adjust all strikes, or other labor troubles, and no allowance will be made for such delays in the time limit herein named.

### **ACCESS TO WORK**

The Engineer may at any time enter upon the work and the premises used by the Contractor, and the Contractor shall provide proper and safe facilities by means of ladders or otherwise to secure convenient access to all parts of the work, and all other facilities necessary for inspection, as may be required by the Engineer.

### **GUARANTEE**

The Contractor hereby guarantees all work performed under this contract for a period of one (1) year from the date of the "Final Acceptance and Payment" thereof by the City as follows:

Against all faulty or imperfect materials and against all imperfect, careless, and/or unskilled workmanship.

That the work performed under this contract, including all mechanical and electrical equipment and appurtenances, and each and every part thereof, shall operate (with proper care and maintenance) in a satisfactory and efficient manner and in accordance with the requirements of these contract documents.

The Contractor agrees to replace with proper workmanship and materials, and to re-execute, correct, or repair, without cost to the City, any work which may be found to be improper or imperfect and/or which does not operate in a satisfactory manner or fails to perform as specified.

The guarantee obligations assumed by the Contractor under these contract documents shall not be held or taken to be in any way impaired because of the specifications, indication or approval by or on behalf of the City of any articles, materials, means, combinations, or things used or to be used in the construction, performance, and completion of the work or any part thereof.

No use or acceptance by the City of the work or any part thereof, nor any failure to use the same, nor any repairs, adjustments, replacements, or corrections made by the City due to the Contractor's failure to comply with any of his obligations under these contract documents, shall impair in any way with the guarantee obligations assumed by the Contractor under these contract documents.

### **HOURS OF LABOR**

Eight (8) hours shall constitute a day's work for all laborers, workmen, or mechanics directly employed by the Contractor and all subcontractors on the project, except in time of war or at other times of emergency when it may be necessary to work more than eight (8) hours in any one calendar day to protect or save human life or property, and the Contractor or any of his subcontractors shall not require or permit any laborer, workmen, or mechanics to work more than eight (8) hours in any one calendar day while engaged on the project, except at times hereinbefore specifically mentioned.

**WAGES PAYABLE UNDER MUNICIPAL CONTRACTS, ETC.**

SECTION 2-1, Wilmington Code, Chapter 20, Article IV.

**SECTION 20-44**

**Definitions.**

For the purposes of this article, the following words and phrases shall have the meanings respectively ascribed to them by this section:

- "City Work"** All building or construction work or projects of any kind or nature, including repair, alteration, and remodeling done on behalf of the City under any contract awarded by the City for building or constructing any building or structure, or the repair, alteration, and remodeling thereof or any other project subject to the determination by the Procurement and Records Division Manager and the State Department of Labor and Industrial Relations in accordance with the provisions of Sections 101 to 129 of Title 19 of the Delaware Code, involving the hourly wages for the respective occupational classifications within a given craft, trade, or industry for the City area.
- "Contractor"** Any employer who has been awarded any contract for the City work as defined herein.
- "Contracts"** Contracts for the performance of City work entered into by the City with contractors and all contracts entered into between such contractors and subcontractors involving or regarding such work.
- "Employee"** A workman or mechanic of the employer.
- "Employer"** Any person who is a party to a contract or subcontract for the performance of any City work as defined herein.
- "Occupational Classifications"** The specific categories of jobs within a given craft, trade, or an industry for which a separate hourly wage rate for the City area as is determined by the Procurement and Records Division Manager and the State Department of Labor and Industrial Relations in accordance with the provisions of Section 101-129 of Title 19 of the Delaware Code.
- "Prevailing Wages"** An aggregate of:
- 1) The hourly wages for the respective occupational classifications within a given craft, trade, or industry for the City area determined by the Procurement and Records Division Manager and the State Department of Labor and Industry Relations in accordance with the provisions of Sections 101-129 of Title 19 of the Delaware Code; provided, however, that during the period of any substantial work stoppage involving rates of wages in a given craft, trade, or industry, such wages for such craft, trade, or industry shall be those as last so determined by the Procurement and Records Division Manager prior to such work stoppage, and

- 2) The additional benefits, for which a monetary equivalent may be determined, and which are given employees pursuant to a bona fide collective bargaining agreement for their respective craft, trade, or industry in the City area, or the monetary equivalent of such benefits.

## SECTION 20-45

### Required Contract Provision

The specifications for all City work contracts shall contain a reference that the minimum wages paid for each occupation classification of employees shall be the prevailing wages as determined by the Procurement and Records Division Manager and the State Department of Labor and Industrial Relations. Each contract, as defined in this article, involving any City work shall contain a provision that all employees performing City work shall be paid at least the applicable prevailing wages. Every contract involving any City work shall contain a provision that the Contractor shall require all subcontractors to comply with and be bound by all of the provisions of this article.

As a condition precedent to awarding of any construction contract by the City, all bidders shall be compelled to agree and abide by any Federal, State, County, or municipal statutes, ordinances, or regulations thereof, pertaining to plans for the hiring of persons belonging to minority groups or to any reasonable plans or agreements formulated among the contractors, construction trade unions, and the various neighborhood civic groups concerned with the elimination of discriminatory hiring practices in the construction industry.

The awarding of any City construction contracts shall be made to the lowest responsible bidder who agrees to abide by all Federal, State, County or municipal statutes or ordinances, or rules or regulations which may prohibit the discriminatory hiring practices by a person's race, color, religion, national origin, or political opinion, and who further agrees to promptly comply with any reasonable plan to be formulated by the hiring of persons of minority groups that results from either Federal, State, County or City statutes, ordinances, rules and regulations, or agreements among the construction trade unions, the contractors, and the various neighborhood groups concerned with the elimination of discriminatory hiring practices.

The Finance Department's Division of Procurement and Records shall notify in writing, or include in all specifications, the pertinent provisions of this section, to apprise all bidders on City construction contracts of this requirement (Ordinance No. 70-055, Section 3).

## SECTION 20-46

### Affidavit of Compliance with Article Prerequisite to Payment by City: Monthly Payroll Report.

All contractors and subcontractors performing City work shall file with the Procurement and Records Division Manager, an affidavit upon each payment being made by the City to such contractors and subcontractors pursuant to a contract that the provisions of this article have been complied with prior to the City making any payment. The affidavit shall also provide that the contractor or subcontractor has posted in a conspicuous place on the job site a list of the prevailing wages for the respective occupational classifications; and he shall submit with the affidavit a monthly report stating the number of workers in each classification, and the total gross payroll paid by him to each classification (Ordinance No. 73-077, Section 1).

## SECTION 20-47

### Violation of Article.

The violation of this article shall be considered a substantial breach of contractor's obligation under the contract; provided, however, that this article shall not be deemed to have been violated where it is contended that a particular craft, trade or industry is not the appropriate one and the wages applicable to the craft, trade or industry working under the contract have been paid the prevailing wages as determined for the craft, trade or industry contract. No contract for City work shall be awarded to any contractor or subcontractor who has violated any provision of this section until five (5) years have elapsed from the date of determination of such violation, and shall be fined no more than five thousand dollars (\$5,000.00) for each violation (Ordinance No. 73-077, Section 2).

### PLANS, ETC., TO BE FOLLOWED

The approved plans attached to and made a part thereof will show the details and dimensions of the work contemplated, which shall be performed in strict accordance therewith and in accordance with the specifications. There shall be no deviation from the plans, specifications, etc., on account of the exigencies of construction, unless approved by the Engineer and authorized in writing.

### INTERPRETATION OF PLANS, ETC.

On all plans, drawings, etc., the following dimensions shall govern in the case of discrepancy between the scales and figures. The Contractor shall take no advantage of any error or omission in the plans or of any discrepancy between the plans and specifications, and the Engineer shall make such corrections and interpretations as may be deemed necessary for the fulfillment of the intent of the specifications and of the plans as construed by him. In all cases of doubt as to the true meaning of the specifications, plans and/or drawings, the decision of the Engineer will be final and conclusive.

### ALTERATION OF PLANS OR OF CHARACTER OF WORK

The Engineer reserves the right to make such alterations in the plans or in the character of the work as may be considered necessary or desirable from time to time to complete fully and perfectly the construction of the work, provided such alterations do not change materially the original plans and specifications of such alterations shall not be considered as a waiver of any condition of the contract nor to invalidate any of the provisions thereof. Should such alterations in the plans or in character of the work be productive of increased cost or result in decreased cost to the Contractor, a fair and equitable sum therefor to be agreed upon in writing by the Contractor and the Engineer, before such work is begun, shall be added to or deducted from the contract price, as the case may be. No allowance will be made for anticipated profits on the work omitted.

### PLANS AND SPECIFICATIONS FURNISHED TO CONTRACTOR

The Contractor will be supplied by the Engineer with a reasonable number of copies of the plans and specifications and he shall have available on the work at all times during the prosecution of the work, one (1) copy of said plans and specifications.

### TEST OF SAMPLES OF MATERIALS

All tests of materials will be made by the City in accordance with official approved methods as described or designated. The Contractor shall cooperate with and assist the Engineer in taking samples and packing them for shipment to a laboratory.

## **STORAGE OF MATERIALS**

Materials shall be stored so as to insure the preservation of their quality and fitness for the work. When considered necessary, they shall be placed on wooden platforms, or other hard, clean surfaces, and not on the ground, and shall be placed under cover when directed. Stored materials shall be located so as to facilitate prompt inspection. Lawns, grass plots, or other private property shall not be used for storage purposes without written permission of the owner or lessee.

## **QUALITY OF MATERIALS AND WORKMANSHIP**

All materials furnished and all work done in carrying out the contract shall be of the best quality and especially adapted to the services required. Wherever the characteristics of any materials are not particularly specified, such materials shall be used as is customary in first class work of the nature for which the material is employed. The source of supply and quality of each of the materials shall be approved by the Engineer before the delivery is started. Representative preliminary samples of the character and quality herein described shall be submitted by the Contractor when indicated or directed, for examination or test, and written approval of the quality of such samples shall be received by the Contractor prior to obtaining materials from the respective sources of supply. Only such materials as conform to the requirements of these specifications shall be used in the work. All materials proposed to be used may be inspected at any time during the progress of their preparation and use. All materials shall be approved before being incorporated in the work, and shall be new and unused.

Representative samples of all materials requiring laboratory tests shall be taken, and such materials shall be used only after written approval has been received by the representative of the Engineer in charge of the work, and only so long as the quality of said materials remains equal to requirements.

## **DIMENSIONS AND LEVELS**

The Contractor shall be solely responsible for construction of work at proper lines and elevations and no plans as to instructions or orders received from any source other than the information contained in the drawings or specifications, or in written orders of the Engineer, shall justify departure from the lines and elevations as shown on the plans.

## **MAINTENANCE, REPAIRS, ETC., AFTER COMPLETION**

The Contractor, at his entire cost and expense, shall maintain all portions of the work included in the contract to meet the requirements of these specifications for and during a period of three (3) months from and after the date of the conditional acceptance of the entire work by the City, and in addition, shall at his entire cost and expense, make all repairs and replacements of the work and appurtenances which may become necessary, in the judgment of the Engineer, at any time or times, during said three (3) months, on account of any failure or defects in said work and appurtenances due to improper work done or materials furnished by the Contractor.

## **DELINQUENT TAXES, ETC.**

The City shall have the right to set off against all monies due and payable under the provisions of this contract the sum representing the total amount of delinquent taxes and/or water sewer charges owed the City by the Contractor or any of its subcontractors. The monies so set off shall be credited to the amount shown by the tax and or water sewer records to be delinquent, said records shall be prima facie evidence of the true and correct amount of taxes and or water sewer charges due to the City.

The term "delinquent taxes" as used herein applies only to uncollected taxes, license fees, and penalties owed by the Contractor or subcontractor, a subsidiary, or principal owner thereof; "principal owner" as used herein is one which owns a majority share or otherwise maintains a controlling interest in the Contractor or subcontractor. The City shall notify the Contractor in writing of its intention to make the aforesaid set off. If the Contractor and the City cannot agree as to either the amount or propriety of the set off, a formal hearing shall be held. The scope of said hearing shall be limited to the Contractor's good faith objections as to the validity or propriety of the tax and/or water sewer assessment or contemplated set off. If the dispute remains extant, the amount subsequently set off shall be deemed paid under protest.







# **City of Wilmington DBE Program and Bidders Requirements**

## **DBE PROCUREMENT PROGRAM**

Responsibilities of the Equal Opportunity/Contract Compliance Office (EO/CCO) are assumed by the City of Wilmington's Small, Minority Business Enterprise Office (SMBEO) in the Mayor's Office of Economic Development. The City of Wilmington has established laws and procedures to increase accessibility of contracting opportunities for small and minority businesses. The EO/CCO authority derives from Chapter 35, Article IV of the Wilmington City Code. This section of the Code addresses Equal Opportunity in Employment and City Contracts.

Mayor's Office of Economic Development/SMBEO  
800 North French Street, 3<sup>rd</sup> Floor, Wilmington, DE 19801  
(302) 576-2121 (Office) • (302) 571-4326 (Fax)  
[www.wilmingtonde.gov](http://www.wilmingtonde.gov)

## **DISADVANTAGED BUSINESS PROGRAM**

In the performance of this contract, the contractor agrees to provide the information as described herein and to make its best efforts to include one or more types of disadvantaged businesses as subcontractors.

A Disadvantaged Business Enterprise means a business that is at least fifty-one percent (51%) owned and controlled by one or more socially disadvantaged individuals who, in fact, control the management and daily business operations of the business.

"Disadvantaged Individuals" are those who have been actual victims of discriminatory practices or individuals whose ability to compete in the free enterprise system has been impaired due to diminished capital and credit opportunities as compared to others in the same business who are not so disadvantaged.

In determining the degree of diminished credit and capital opportunities, the City may consider, but shall not be limited to, reviewing the assets and net worth of disadvantaged individuals and disadvantaged businesses.

For purposes of determining the disadvantage in competing for City contracts, there shall be a presumption of economic disadvantage if an individual's net worth, exclusive of up to one hundred and fifty thousand dollars (\$150,000.00) of equity in his or her primary residence, is less than five hundred thousand dollars (\$500,000.00). The City may, in the administration of its programs, direct its assistance toward those economically disadvantaged individuals who are among the chronically unemployed and may identify demographic subgroups of disadvantaged individuals identified by race or national origin whenever current, verifiable local statistics confirm the existence of unemployment rates among such individuals that are more than fifty (50) percent above the prevailing overall unemployment rate statewide.

All contractors doing business with the City shall show good faith efforts to obtain minority and other disadvantaged subcontracting businesses' participation. Good faith efforts shall be evidenced by listing each disadvantaged business enterprise (DBEs) contacted, showing the name and address of each, the names of contact persons, telephone numbers, sources used to identify DBEs, methods used to make contact, dates firms were contacted, responses, dates responses were received, type of subcontract, reasons for rejection if the firm is not used, and estimated value of each subcontract, through completion of the City's Form DBE-1.

The federal set-aside program requirements for any applicable federally funded contract are fully applicable to the City of Wilmington, such that contractors will be subject to federal penalties of non-compliance if a contract or any subcontract awarded involves the federal set-aside program and the contractor fails to meet its requirements as to that program.

## **GOAL STATEMENT PROVISION FOR DISADVANTAGED BUSINESS PARTICIPATION**

In order to expand opportunities and insure fair participation for disadvantaged individuals and businesses in its construction, goods and services and professional service contracts, the City has set purchasing goals for its fiscal year 1991 in each of these three procurement categories. Except to the extent that the Director of the Minority Business Office determines otherwise, such as for utilities, telephone, etc., the City shall endeavor to achieve, and shall require evidence of good faith efforts by bidders and contractors to achieve the goals of contracting with disadvantaged individuals or disadvantaged businesses for the following percentages of the total dollar amount of each contract in these three purchasing categories:

1. A goal of 20% for all construction contracts;
2. A goal of 10% for all professional service contracts; and
3. A goal of 5% for all goods and other contracts.

### **Notes:**

1. If the contractor customarily performs the work required in any subcontracting category by workers regularly employed by the contractor in his own organization, the contractor does not have to try to subcontract such work to others solely to comply with the DBE requirements. In such cases, however, the contractor shall clearly note this fact on the applicable DBE form(s), and the burden of proof shall be on the contractor to demonstrate the accuracy thereof upon inquiry by the City.
2. Female-owned businesses do **not**, per se, qualify as DBEs.
3. Questions regarding the DBE program and directory should be directed to the City's EEO/Contractor Compliance Office at (302) 576-2121.

## **ADDITIONAL GOOD FAITH EFFORT (CHANGES TO Chapter 35 of the City Code)**

Ordinance No. 09-057, effective December 1, 2009, requires the following DBE changes within the "Good Faith Efforts" in bidding regarding disadvantaged business enterprises (DBE's).

### **Subcontractors Listing**

Identify all subcontractors that the bidder plans to utilize as well as listing the amount of money that will be paid to each of the subcontractors as part of the contract

### **DBE Replacement**

Contractors are further required to make good faith efforts to replace any disadvantaged business enterprise ("DBE") that is terminated or has otherwise failed to complete its work on a contract. In such situations, the general contractor shall be required to notify immediately the City's DBE Office and provide reasonable documentation regarding any DBE's inability or unwillingness to perform the contracted work. The City's DBE Office shall require the general contractor to obtain prior approval for the DBE that will be used as a substitute, and the general contractor must provide copies of new or amended subcontracts along with documentation of the good faith efforts made in acquiring the substitute DBE.

### **DBE Payment**

General contractors shall pay all correct invoices for the completed work of any DBE subcontractor within 10 days of receipt by the prime contractor of payment by the City. Noncompliance with this section shall subject the general contractor to penalties as provided in Section 35-135(e).

The ordinance further provides administrative additional penalties for noncompliance in addition to the penalties already provided for in the Ordinance:

1. Suspension of contract;
2. Withholding of contract funds;
3. Termination of contract based on material breach;
4. Refusal to accept a future bid; and
5. Disqualification from eligibility for providing goods or services to the City for a period not to exceed 2 years.

## **DBE FORMS**

Contractors must file with the City, as applicable, the City's DBE Forms as follows:

1. **\*DBE-1:** A listing of the subcontractors included in the bid, by which a bidder acknowledges having read the DBE goal provisions in Attachment 1 and states that the bidder will expend a percentage of the dollar amount of the contract for DBE subcontractors, if any.
2. **\*DBE-2:** A listing of the subcontractors and other information to provide evidence of good faith efforts to include DBE's in subcontracts. This form must be completed and submitted with the bid, regardless of the level of DBE participation.
3. **\*DBE-3:** DBE verification form stating the ownership information regarding any business seeking to qualify as a City-certified DBE, if not listed in DBE Directory.
4. **DBE-4:** A DBE contract participation report requiring that the general contractor submit a report regarding DBE contract participation at the time the contract is entered into, when 50% and when 100% of each DBE subcontractor's portion of the construction project has been completed.
5. **\*DBE-5:** A listing of **ALL subcontractors** to be utilized on the contract. This form must be completed and submitted with the bid, regardless of the level of DBE participation.

### **FEDERAL Dollars involved in City Contracts:**

A DBE Utilization form(s), including reference to minority business enterprise participation if a federal program is involved, and an indication as to whether a disadvantaged business enterprise (DBE) status is claimed. These EPA (DBE Forms 6100-3 & 6100-4) forms are required by both the SRF and EPA Grant funding programs.

If you need additional information on the DBE Program or assistance completing the DBE Forms, please contact the office by one of the following methods:

Email: [smbeo@wilmingtonde.gov](mailto:smbeo@wilmingtonde.gov)

Phone: (302) 576-2121

Address: Small, Disadvantage Business Enterprise Office (SMBEO)  
Mayor's Office of Economic Development  
Louis L. Redding Building, 3<sup>rd</sup> Floor  
800 North French Street  
Wilmington, DE 19801  
[www.wilmingtonde.gov](http://www.wilmingtonde.gov)

---

\*Mandatory to be submitted back with Bid Documents.

## **EFFORTS TO OBTAIN DBE SUBCONTRACTORS DBE FORM 1 – DBE FORM 2 EXPLANATION**

**[NOTE: DBE FORM-2 MUST BE COMPLETED BY ALL BIDDERS REGARDLESS OF THE LEVEL OF PARTICIPATION OF DBEs IN THE BID.]**

All contractors doing business with the City are required to show good faith efforts to obtain DBE subcontracting businesses' participation. The burden is on the bidder to evidence such good faith efforts by means of the information required on this page. Failure to complete this form and/or failure to make good faith efforts to obtain DBE participation are grounds for rejecting any bid. Further, bidders are expected to make such good faith efforts to obtain DBE participation in connection with each and every subcontract, if any. The City's goals for DBE participation are listed on Attachment 1 to this form. These goals are not set-aside requirements, but they are the overall goals which the City is endeavoring to achieve through the disadvantaged business program. Each person or firm who or which submits a bid for City contracts is expected to demonstrate good faith efforts by actively and aggressively seeking out DBE participation in the contract to the maximum extent, to meet the City's goals, given all relevant circumstances, and shall complete all forms and follow guidelines as required by the Minority Business Office. The following are examples of the kinds of efforts that may be taken but are not deemed to be exclusive or exhaustive and the City's Minority Business Office may consider other factors and types of efforts that may be relevant:

1. Efforts made to select part of the work to be performed by DBEs in order to increase the likelihood of achieving the City's goal for that type of contract. Selection of parts of the work should at least equal the City's goal for DBE participation in that type of contract.
2. Written notification, at least ten (10) days prior to the opening of a bid, soliciting individual DBEs interested in participation in the contract as a subcontractor and for specific items of work.
3. Efforts made to negotiate with DBEs for specific items of work as detailed below and whether initial contacts to solicit DBE participation were followed up to determine with certainty whether DBEs were interested. A description of information provided to DBEs regarding plans and specifications and estimated quantities for parts of the work to be performed. A statement of why additional agreements with DBEs were not reached. Documentation of each DBE contacted but rejected and the reasons for the rejection.
4. Documentation that DBEs are not available or not interested.
5. Advertisements in general circulation media, trade association publications, and DBE media of interest in utilizing DBEs and specific areas of interest.
  - a. Efforts to use effectively the services of organizations that provide assistance in recruitment and placement of DBEs.
  - b. Whether the bidder selected portions of the work to be performed by DBEs in order to increase the likelihood of meeting the contract goals. This includes, where appropriate, breaking out contract work items into economically feasible units to facilitate DBE participation, even when the bidder might otherwise perform these work items with its own forces.

## **DBE FORM 3 – DBE FORM 4 – DBE FORM 5 EXPLANATION**

### **DBE FORM 3**

**DBE-3:** DBE verification form stating the ownership information regarding any business seeking to qualify as a City-certified DBE.

- This form must be submitted back with the bid when the contractor is working with a company who they believe to be eligible for the City of Wilmington's DBE Program. The SMBEO Office reserves the right to determine the eligibility and verification of eligibility for the firm listed on DBE Form 3.
- The burden is on the bidder to evidence such good faith efforts by means of providing the contact information for the DBE firm listed on the DBE Form 3. If a firm is determined to be an eligible DBE firm, the total dollar value of the participation by the DBE will be counted toward the contract requirement. The total dollar value of participation by a certified DBE will be based upon the value of work actually performed by the DBE and the actual payments to DBE firms by the Contractor.
- Failure to complete the DBE 3 form and/or failure to make good faith efforts to obtain DBE participation are grounds for rejecting any bid.

### **DBE FORM 4**

**DBE-4: DISADVANTAGED BUSINESS ENTERPRISE – CONTRACT PARTICIPATION REPORT**

- The Contractor shall provide the DBE Office with an accounting of payments made to Disadvantaged Business Enterprise firms, including material suppliers, contractors at all levels (prime, subcontractor, or second tier subcontractor). This accounting shall be furnished to the DBE Office when the contract is entered into by the general contractor and the subcontractor, when 50% and when 100% of each DBE subcontractor's portion of a project has been completed. Failure to submit this information accordingly may result in the following action or other action as deemed by the City:
  1. Withholding of money due in the next partial pay estimate; or
  2. Contractor may be disqualified from further bidding for a period as designated.

### **DBE FORM 5**

**DBE-5 SUBCONTRACTORS' REPORT**

- The Contractor shall provide the DBE Office with a listing of ALL sub contractors to be entered into contract with this bid. DBE subcontractor(s) are not to be listed on this form but on form DBE #1 (Ord. 09-057).
- Failure to complete the required Subcontractor's form (DBE Form 5) will be grounds for the disqualification of such bid as being a responsive bid.

**To Be Submitted with Bid**

CONTRACT: \_\_\_\_\_

FORM DBE-1  
(Rev. 10/09)

***Failure to submit this completed form will be cause for rejection of your proposal***

Bidder acknowledges that he has read the D.B.E. goal provisions of the City for this fiscal year and that bidder will expend the dollar amount of the contract for D.B.E. subcontractors through the use of the following disadvantaged business enterprises, subject to the certification by the City, as subcontractors and that Bidder has made good faith efforts\* as evidenced by its listing of disadvantaged businesses that were contacted as detailed herein and on the following pages. (Must be completely filled out.)

**CITY OF WILMINGTON  
DISADVANTAGED BUSINESS ENTERPRISE ("D.B.E.")  
SUBCONTRACTOR LISTING**

D.B.E. Firm Name IRS Numbers	Mailing Address & Contact Number	Type of Service	Dollar Amount of Contract
Total Dollar Amount to be Expended for Disadvantaged Business Enterprises			
Total Amount of Contract			
Percentage of Contract used for D.B.E.			

\_\_\_\_\_  
**Name of Authorized Official of Bidder**

\_\_\_\_\_  
**Title**

\_\_\_\_\_  
**Company**

\*Good faith efforts shall be evidenced by listing each and every disadvantaged business enterprise (DBEs) contacted, showing the name and address of each, the names of contact persons, telephone numbers, sources used to identify DBEs, methods used to make contact, dates firms were contacted, responses, dates responses were received, type of subcontract, reasons for rejection, and estimated value of subcontract.



**To Be Submitted with Bid**

CONTRACT: \_\_\_\_\_

FORM DBE-2  
(Rev. 10/09)

*Failure to submit this completed form will be cause for rejection of your proposal*

DBE Firm Name/Address	Contact Person(s) Email or Phone Number	Dates Contacted Initially and in Follow Up; Methods Used	Type of Sub-contractor plus Estimated Value	Reason for Rejection (If Firm Not Used) (If Bid "Too High" Also Indicate Value)
1.			\$	
			\$	
2.			\$	
			\$	
3.			\$	
			\$	

Were advertisements placed in general circulation media, trade association publications, and DBE media interested in DBE participation? If so, state details of the advertisement. If not, state why not.

What efforts were made to use the services of organizations that provide assistance in recruitment and placement of DBEs?

The following are examples of actions that may not be used as justification by the contractor or bidder for failure to meet DBE participation goals:

1. Failure to contract with a DBE solely because the DBE was unable to provide performance and/or payment bonds.
2. Equipment idled by contract with DBE.
3. Rejection of a DBE because of its union or non-union status.

If more DBE firms have been contacted, please list with supplemental form(s) on additional pages.

**To Be Submitted with Bid if DBE is not listed in City DBE Directory**

CONTRACT: \_\_\_\_\_

FORM DBE-3  
(Rev. 10/09)

*Failure to submit this completed form will be cause for rejection of your proposal*

**CITY OF WILMINGTON  
DISADVANTAGED BUSINESS REGISTRATION VERIFICATION FORM**

1.	NAME:		
2.	ADDRESS:		
3.	PHONE:	PRODUCT OR SERVICE LINE:	
4.	TYPE OF FIRM: <input type="checkbox"/> Corporation <input type="checkbox"/> Partnership <input type="checkbox"/> Individual <input type="checkbox"/> Other _____		
5.	EMAIL:		
6.	DATE OF ORIGATION OF FIRM:	EMAIL:	
7.	BUSINESS LICENSES HELD:	City:	State:      Other:
8.	DISADVANTAGED OWNERSHIP OF FIRM:		
	NAME	OWNERSHIP % OF FIRM	DISADVANTAGED BUSINESS
a.			
b.			
c.			
d.			
e.			
f.			
9.	NON-DISADVANTAGED OWNERSHIP OF FIRM:		
	NAME	OWNERSHIP % OF FIRM	
a.			
b.			
c.			
d.			
e.			
f.			
8.	I hereby certify that the information above is true and complete to the best of my knowledge and belief, and that I have been duly authorized to make this certification on behalf of the firm.		

NAME (printed) \_\_\_\_\_

SIGNATURE \_\_\_\_\_

DATE \_\_\_\_\_

TITLE \_\_\_\_\_

FOR OFFICE USE ONLY

DATE RECEIVED: \_\_\_\_\_  
DATE APPROVED: \_\_\_\_\_  
INFORMATION VERIFIED: \_\_\_\_\_

The General Contractor is required to submit this Compliance Report to the Disadvantaged Business Development Officer, City/County Building, 3<sup>rd</sup> Floor, 800 French Street, Wilmington, Delaware 19801, when the contract is entered into by the general contractor and the subcontractor, when 50% and when 100% of each DBE subcontractor's portion of a construction project has been completed.

**DISADVANTAGED BUSINESS ENTERPRISE  
CONTRACT PARTICIPATION REPORT**

1. Contract No. \_\_\_\_\_ Amount of Contract \$ \_\_\_\_\_
2. Name of General Contractor: \_\_\_\_\_
3. Address: \_\_\_\_\_
4. E-Mail Address: \_\_\_\_\_
5. The above-named contractor intends to fulfill its commitment to expend \$ \_\_\_\_\_ (\_\_\_\_%), of its contract with Disadvantaged Business Enterprises ("DBEs"). The following year-to-date expenditure(s) has been made with a DBE Subcontractor(s):

1.			
2.			
3.			

CONTRACT COMPLETION DATE: \_\_\_\_\_

\_\_\_\_\_  
General Contractor

\_\_\_\_\_  
Name of Authorized Officer

\_\_\_\_\_  
Date

\_\_\_\_\_  
DBE Subcontractor

\_\_\_\_\_  
Signature of Authorized Officer

\_\_\_\_\_  
Date

<b>Office Use Only (Prime)</b>
Payment Received: _____ Amount: _____ Date: _____ Payment Received: _____ Amount: _____ Date: _____

\_\_\_\_\_  
City of Wilmington

\_\_\_\_\_  
Date

\_\_\_\_\_  
Contract Compliance Officer's Name

\_\_\_\_\_  
City of Wilmington

\_\_\_\_\_  
Date

\_\_\_\_\_  
Contract Compliance Officer's Signature

CONTRACT: \_\_\_\_\_

*Failure to submit this completed form will be cause for rejection of your proposal*

**CITY OF WILMINGTON**  
**SUBCONTRACTOR LISTING**  
**(Do not include DBE Firms to be utilized)**

Total Dollar Amount to Non-Disadvantaged Business Enterprises			
Total Amount of Contract			

Bidder acknowledges that he has identified all sub contractors that will be utilized as well as listing the amount of money that will be paid to each of the subcontractors as part of the contract (use additional pages if necessary).

\_\_\_\_\_  
Name of Authorized Official of Bidder

\_\_\_\_\_  
Title

\_\_\_\_\_  
Company

\_\_\_\_\_  
Date

**RESPONSIBLE CONTRACTOR  
CERTIFICATION**

**CITY OF WILMINGTON, DELAWARE  
DEPARTMENT OF PUBLIC WORKS  
STREET PAVING, PHASE X**

**Contractor/Subcontractor  
Responsibility Certification**

**Contractors:** The City of Wilmington Division of Procurement and Records must receive this executed form not later than at the time of bid submission. It may be submitted prior to bid submission for review.

**Subcontractors:** Must submit this form to requesting contractor.

**CONTRACTOR/SUBCONTRACTOR RESPONSIBILITY CERTIFICATION  
FOR DEPARTMENT OF PUBLIC WORKS CONTRACTS  
VALUED AT MORE THAN \$100,000**

Name of Company: \_\_\_\_\_

Address: \_\_\_\_\_

\_\_\_\_\_

\_\_\_\_\_

Contract/Project Name: \_\_\_\_\_

Contract Number: \_\_\_\_\_

As a condition of performing "City work" (all building or construction work or projects of any kind or nature as provided in City Code Sec. 2-651) for the City of Wilmington, Delaware, contractors and subcontractors (hereinafter referred to as "Bidders") must meet certain responsible contractor requirements and qualifications specified in the Wilmington City Code, Chapter 2, Article VI, Division 6, Subdivision III (Sec. 2-561 et seq.). Pursuant thereto, the Company named above certifies the following:

***PLEASE INITIAL EACH ITEM TO INDICATE COMPLIANCE  
(X's and check marks are not acceptable)***

- \_\_\_\_\_ 1. The Bidder and its employees have all valid, effective licenses, registrations, or certificates required by federal, state, county, or local law, including, but not limited to, licenses, registrations, or certificates required to:
- a. do business in the City of Wilmington and the State of Delaware; and
  - b. perform the contract work, including, but not limited to, licenses, registrations or certificates for any type of construction or maintenance trade work or specialty work which the Bidder proposes to self-perform.
- \_\_\_\_\_ 2. The Bidder meets all:
- a. bonding requirements as required by the applicable law or contract specifications; and
  - b. insurance requirements per applicable law or contract specifications, including general liability insurance, workers' compensation insurance, and unemployment insurance.
- \_\_\_\_\_ 3. The Bidder has a satisfactory record of integrity in accordance with Sec. 2-537(4) of the City Code, which further states as follows:

The following provisions, while not exclusive, shall be sufficient to justify a finding of non-responsibility:

- a. failure to pay taxes and fees due and owing to the City;
  - b. a conviction of the contractor or a principal officer thereof for commission of a criminal offense, as incident to obtaining or attempting to obtain a public contract or in the performance of such contract;
  - c. a conviction, of the contractor or principal officer thereof, under state or federal statutes, for embezzlement, theft, forgery, bribery, falsification or destruction of records, receiving stolen property, or any other offense indicating a lack of business integrity or business honesty which currently, seriously and directly affects responsibility as a city contractor.
- \_\_\_\_\_ 4. The Bidder has a satisfactory record of timely performance of City contracts in accordance with Sec. 2-537(3) of the City Code, which further states as follows:

Contractors who are seriously deficient in current contract performance, when the number of contracts and the extent of deficiency of each are considered, shall, in the absence of evidence to the contrary or circumstances properly beyond the control of the contractor, be presumed to be unable to meet this requirement. Past unsatisfactory performance due to failure to apply necessary

tenacity, or perseverance to do an acceptable job, shall be sufficient to justify a finding of non-responsibility.

\_\_\_\_\_ 5. The Bidder has a satisfactory record of performance of contractual provisions in accordance with Sec. 2-537(5) of the City Code, which further states as follows:

Violation(s) of contract provisions of a character which justify a finding of non-responsibility include:

- a. deliberate failure without good cause to perform in accordance with the specifications provided in the contract;
- b. a recent record of failure to perform or of unsatisfactory performance in accordance with the terms of one or more contracts;
- c. in particular, failure to comply with prevailing wage and related federal, state, and city requirements;

provided, however, that failure to perform or unsatisfactory performance caused by acts beyond the control of the contractor shall not be considered to be a basis for a finding of non-responsibility.

\_\_\_\_\_ 6. The Bidder has a satisfactory record of good faith efforts to achieve disadvantaged business enterprise participation in accordance with Sec. 2-537(8) of the City Code.

\_\_\_\_\_ 7. The Bidder has not been debarred or suspended by any federal, state or local government agency or authority in the past three years.

\_\_\_\_\_ 8. The Bidder has not defaulted on any project in the past three years.

\_\_\_\_\_ 9. The Bidder has not had any type of business, contracting or trade license, registration, or other certification revoked or suspended in the past three years.

\_\_\_\_\_ 10. The Bidder and its owners have not been convicted of any crime relating to the contracting business in the past ten years.

\_\_\_\_\_ 11. The Bidder has not at any time been found in violation of any federal, state or local prevailing wage law.

\_\_\_\_\_ 12. The Bidder has not within the past three years been found in violation of any law applicable to its contracting business, including, but not limited to, licensing laws, tax laws, prompt payment laws, wage and hour laws, environmental laws or others, where the result of such violation was the payment



of a fine, back pay damages or any other type of penalty in the amount of \$1,000 or more.

\_\_\_\_\_ 13. The Bidder will pay all craft employees that it employs on the project the current wage rates and fringe benefits as required under applicable federal, state or local wage laws.

\_\_\_\_\_ 14. All craft labor that will be employed by the Bidder for the project have completed at least the OSHA 10 hour training course for safety established by the U. S. Department of Labor, Occupational Safety & Health Administration.

\_\_\_\_\_ 15. The Bidder will employ craft employees in all classifications and individual trades required to successfully perform the work related to the project.

\_\_\_\_\_ 16. The Bidder has participated in a Class A Apprenticeship Program for the past twelve months, at a minimum, for each separate trade or classification in which it employs craft employees and shall continue to participate in such program or programs for the duration of the project. The twelve month participation requirement may be waived during the first year of implementation of this Ordinance; provided that the firm is participating in a Class A Apprenticeship Program at the time it submits its bid and submits information showing that the construction craft workers it plans to use have adequate skills to successfully perform the project. Once the Ordinance has been in effect for twelve months, i.e., September 4, 2013, a waiver of this requirement will no longer be available.

- a. for purposes of this section, a Class A Apprenticeship Program is an apprenticeship program that is currently registered with and approved by the U.S. Department of Labor or a state apprenticeship agency and has graduated apprentices to journeyman status for at least three of the past five years;
- b. to ensure compliance with this section, the Bidder shall provide, with this certification, a list of all trades or classifications of craft employees it will employ on the project and documentation verifying it participates in a Class A Apprenticeship Program for each trade or classification listed;
- c. in order to enhance the training of its workforce and to comply with this subsection, the firm must enroll a new person in a Class A Apprenticeship Program for each bid submitted to the City.

\_\_\_\_\_ 17. The Bidder shall make all reasonable best efforts to ensure that fifteen percent (15%) of the workforce hired for the project, especially with respect to new workers recruited and hired for the project, includes City of Wilmington residents. To ensure compliance with this section, the Bidder will also make residency information on its workforce available to the City upon request.

- \_\_\_\_\_ 18. The Bidder has all other technical qualifications and resources, including equipment, personnel and financial resources, to perform the referenced contract, or will obtain same through the use of qualified, responsible contractors.
- \_\_\_\_\_ 19. The Bidder acknowledges that within seven (7) calendar days following the date of receipt of Notice of Intent to Award Contract, it will provide a list of subcontractors it plans to utilize for services in the performance of the contract. The list must include a brief description of the subcontractor's scope of work. In addition, each subcontractor providing services equaling or exceeding \$100,000 must provide executed Subcontractor Responsibility Certifications containing information equivalent to that required for the Bidder in the Contractor Responsibility Certification. Note: Bidder must initial this item regardless of the value of the subcontract services.
- \_\_\_\_\_ 20. If at any time during the past five (5) years the Bidder has controlled or has been controlled by another corporation, partnership or other business entity operating in the construction industry, it will disclose such facts by attaching a detailed statement to its Contractor Responsibility Certification explaining the nature of the relationship.
- \_\_\_\_\_ 21. The Bidder acknowledges that it shall be required to provide appropriate documentation of the conditions specified in this Contractor/Subcontractor Responsibility Certification. The Bidder also understands that the City of Wilmington may request additional information or documents at any time as the City of Wilmington deems necessary to evaluate the responsibility of Bidder. Bidder agrees to provide such additional information or supporting documentation for this Certification.
- \_\_\_\_\_ 22. If a Bidder fails to provide the Contractor Responsibility Certification required by this section, the Bidder shall be disqualified from bidding the contract. If a Bidder fails to provide other information or documentation required by the City of Wilmington, it may be disqualified from being awarded the contract.
- \_\_\_\_\_ 23. The Bidder shall notify the City within seven days of any material changes to all matters attested to in this certification.

Under the penalty of perjury, the Bidder's authorized representative hereby certifies that all information included in the Contractor Responsibility Certification or otherwise submitted for purposes of determining the Bidder's status as a responsible contractor is true, complete and accurate and that he/she has knowledge and authority to verify the information in this certification or otherwise submitted on behalf of the Bidder by his or her signature below.

\_\_\_\_\_  
Authorized Signature

\_\_\_\_\_  
Date

\_\_\_\_\_  
Print Name

\_\_\_\_\_  
Title

\_\_\_\_\_  
Witness Signature

\_\_\_\_\_  
Date

PLEASE SUBMIT **SIGNED ORIGINAL** VERSION OF THIS FORM TO:

**CITY OF WILMINGTON  
DEPARTMENT OF FINANCE, DIVISION OF PROCUREMENT  
LOUIS REDDING CITY COUNTY BUILDING  
800 N. FRENCH STREET, 5<sup>TH</sup> FLOOR  
WILMINGTON, DE019801**

Questions regarding the this form can be sent to  
[procurement@wilmingtonde.gov](mailto:procurement@wilmingtonde.gov) or call 302.576.2423

# **GENERAL CONTRACT PLAN NOTES**

**CITY OF WILMINGTON, DELAWARE  
DEPARTMENT OF PUBLIC WORKS  
STREET PAVING, PHASE X**

## **CONTRACT DESCRIPTION**

The purpose of this contract is to repair sections of bituminous concrete pavement on roads in The City of Wilmington. Work includes saw-cutting, milling, paving, hot-mix patching, crack sealing, paint striping, and utility adjustments.

The specific work sites are not listed herein but will be assigned as available by the City of Wilmington via work orders.

The duration of this open-end contract shall be for a period of (1) year from the date of initial "Notice to Proceed" letter, with the option to extend the Contract for (2) one year extensions. The two (2) one-year extensions must be approved by both parties in writing, at least 30 days prior to the expiration of the existing Contract. The two one-year extensions will be approved separately. The Performance Bond shall be submitted with the Contract extension and shall be subject to any such agreed upon renewal for the extension period. Failure on the part of the Contractor to submit the Performance Bond for the extension period prior to the last working day before the end of the previous period may result in the Contract being Cancelled. It shall be the Contractor's responsibility to obtain the forms necessary to renew the Performance Bond each year the Contract is in force.

## **GENERAL CONTRACT PLAN NOTES**

1. All work shall be performed in accordance with the Delaware Department of Transportation Standard Specifications dated June 2021 (as amended by the Supplemental Specifications), the DelDOT Special Provisions, Standard Construction Details, and this project manual. These specifications can be found at [www.deldot.gov](http://www.deldot.gov) under Information, Publications, and Manuals.
2. An updated Performance Bond shall be submitted at the beginning of each fiscal year. Failure on the part of the Contractor to submit the Performance Bond may result in the Contract being cancelled.
3. Whenever the word "Contractor" is used in this contract, it shall refer to the person or persons, company or corporation furnishing the services required.
4. Whenever the word "City" or "Engineer" is used, it shall refer to the person or persons, representing the City of Wilmington.
5. Tasking of work in contingent upon authorization of City funding.
6. It is anticipated that all work will occur within the City's existing right of way or easement areas. Should the need occur to trespass onto private property; it will be the responsibility of the City's Project Manager to secure such trespass needs.

CITY OF WILMINGTON, DELAWARE  
Public Works Department

---

7. It is anticipated that all work will occur within the City's right of way. Should the need occur to trespass onto railroad property, including the highway-rail crossing; it will be the responsibility of the Project Manager to obtain written authorization before entering.
8. No utility relocation involvement is anticipated. Should any conflicts be encountered during construction requiring adjustment and/or relocation of the agencies' existing facilities, the necessary relocation work shall be accomplished by the respective agencies' forces, as directed by the City Engineer. Any adjustments of municipally owned facilities shall be done by the City's contractor in accordance with the respective agencies' standard specifications as directed by the City Engineer.

9. Prosecution and Progress of Work

The Contractor shall commence on work indicated on the work order no later than the tenth (10<sup>th</sup>) business day after issuance of that work order unless required materials are not available. Non availability of materials shall be verified by at least three (3) different sources. Verification shall be formal and supplied by the contractor in writing.

Issuance of each work order constitutes the "Notice to Proceed" with the work described on the work order.

If there is a verified non-availability of materials, time charges shall commence on the first (1<sup>st</sup>) working day following the delivery date of materials.

Failure to start assigned work orders in the allowed time constitutes "Failure to Pursue Work" and subjects the Contractor to Liquidated Damages as outlined in section 108 of the Standard Specifications. If work on a specific work order is not completed within the allotted time, Liquidated Damages will be assessed in accordance with Subsection 108.8 and based on the total value of that work order.

Each work order shall be considered a separate unit of work. Upon the substantial completion of the work at an individual location, the Engineer will stop time at the location and may perform a semi-final inspection for the work order location in accordance with Subsection 105.16. The Engineer reserves the right to require the Contractor to add work or make repairs to completed locations until such a location has been accepted by the City. The Contractor must repair all defects in the work caused by poor workmanship or materials at his/her own expense until the City accepts the Contract after Final Inspection.

A Final Inspection will be completed on an annual basis for work completed in a calendar year. Upon satisfactory completion of the Final Punch List, the City will accept the location and release the Contractor from responsibility for the Work at that location. If a work order is sufficiently large and complex as determined by the Engineer, a Final Inspection may be held upon the individual completion of that work order.

10. Payment will be monthly for the work completed as outlined in section 109.8.

CITY OF WILMINGTON, DELAWARE  
Public Works Department

---

11. Retainage: General Conditions, Partial Payments paragraph two (2) has been deleted and replaced with: Ten Percent (10%) will be deducted from the total amount earned for each work order until the entire work order location has been satisfactorily completed. Upon the completion of the work order retainage will be reduced to five percent (5%). Retainage will be eliminated entirely once final acceptance has been made by the City for work included on a given work order.
12. The contractor shall not trespass on private property unless the City has acquired a "Temporary Trespass Agreement" from the property owner. If the work is within a permanent easement, the work shall not begin until the adjacent property owners have been notified. Prior to starting work on private property, The Contractor shall notify affected property owners in writing of the proposed work dates, scope of work, proposed work hours, and the City's contact phone number. Compensation for notification shall be incidental to Item 763000 (Initial Expense/De-Mobilization).
13. No environmental permits are required for this work provided no jurisdictional wetlands or waters are impacted.
14. Proper Disposal of construction related wastes shall be the sole responsibility of the contractor.
15. Underground utilities may be present at ALL locations. Therefore, all standard practices and procedures regarding utilities shall be followed. The Contractor shall contact Miss Utility of Delaware prior to starting each work order. The Contractor is responsible for the support and protection of all utility when excavating. The Contractor is responsible for ensuring proper clearances, including safety clearances, from overhead utilities for construction equipment. The Contractor is advised to check the site for access purposes for his equipment, and make arrangements directly with the utility companies for field adjustment for adequate clearances if necessary.
16. The determination of subsurface conditions, including the existence and location of any underground utilities or structures shall be the responsibility of the contractor. No additional allowance will be made for any subsurface condition found to exist. Notwithstanding any other provision of this contract, the contractor shall not proceed with his work until conferring with the engineer, the utility companies, and the municipal authorities in an effort to secure exact utility locations. The contractor shall not begin any construction around or immediately adjacent to utilities without notifying their owner. The contractors shall call "Miss Utility" at 1-800-282-8555 not less than 2 full working days prior to starting work. The Contractor is responsible for utilities on the project and shall refer to and abide by the Delaware Code, Title 26, Chapter 8 – Underground Utility Damage Prevention and Safety.

The Contractor must submit one copy to the Engineer and retain an on-site copy of all applicable Miss Utility "confirmation" tickets while working within each location.

Any damage to the utility services must be repaired at the Contractor's expense. Such damage shall be reported and repaired immediately. The Contractor's onsite supervisor shall have a working cell phone and contact list for the affected utility companies in the event of an emergency. If a gas line is encountered and there is no apparent damage to the line, call Delmarva Power immediately for further instructions. If a gas line is encountered and there is damage to the line, turn off all power equipment; call "911" and Delmarva Power immediately; evacuate nearby residences/businesses immediately;

CITY OF WILMINGTON, DELAWARE  
Public Works Department

---

cordon off the area immediately and await response from Delmarva Power /fire/police. Damage to the lines includes a nick or bends in the pipe, smell of gas, noticeable leak, etc.

Utility operators such as the following may have facilities involved in the construction of this project:

Delmarva Power (gas and electric)  
Department of Public Works, City of Wilmington (sanitary and storm sewer)  
Water Division, Department of Public Works, City of Wilmington (water)  
Verizon (telephone)

All privately owned utility apparatus will be adjusted by the utility owner. The contractor shall be responsible for coordinating work with the utility owner. This includes prior notice to the utility owner of the necessity to adjust the utility owners casting.

17. Delete Section 104.2.B.4 of DelDOT Standard Specification, and replace with the following:

*The City reserves the right to, at any time prior to completion of the contract, issue plan revisions, make adjustments in Contract item quantities, or make such alterations considered necessary to satisfactorily complete the Contract.*

*The City reserves the right to increase or decrease the quantities of pay items specified in the Contract. Such additions or deletions shall not be cause for an increase or decrease in Contract unit bid prices. The "Change" threshold of plus and minus 25%, as described in Subsection 104.2 of DelDOT Standard Specifications dated June 2021 shall not apply to this Contract. Quantity increase or decreases of plus or minus 25% or greater shall not be justification for allowance.*

*The plan revisions and quantity adjustments described above do not invalidate the Contract or release the Contract surety. Payment for these changes shall exclude any amount for loss of anticipated profits alleged to result from the change.*

*When payment for the Contract work cannot be agreed upon by the Contractor and the City prior to starting such work ordered, the City may direct the Contractor to perform the work under Force Account provisions of Subsection 109.4. The Contractor will proceed immediately with the work so ordered and such direction shall neither invalidate the Contract, nor release surety.*

18. Trash, rubbish, debris or brush that hampers repair / maintenance work in this Contract (as determined by the Engineer), shall be removed within the project limits and shall be incidental to pay item 763000 (Initial Expense/De-Mobilization).
19. Proper Disposal of construction related wastes shall be the sole responsibility of the Contractor and shall be performed in accordance with all applicable State regulations.
20. Grass and Soil areas within the City right-of-way that have been damaged by equipment during this contract, shall be restored with topsoil, seed and mulch at the Contractor's own expense, and in accordance with requirements for 908003 (Topsoil, 4" Depth) and 908014 (Permanent Grass Seeding, Dry Ground) and 908020 (Erosion Control Blanket).



CITY OF WILMINGTON, DELAWARE  
Public Works Department

---

21. The Contractor shall guarantee all work to be free from defects for a period of one year from time of owner acceptance. Any defects occurring during this period shall be corrected by the Contractor at no additional cost to the City.
22. Time to perform work assigned per work order shall be developed by the following method and items:

**LEGEND:**

A = TONS OF TYPE "C" IN WORK ORDER

B = SQUARE YARDS PER INCH OF MILLING IN WORK ORDER

C = SQUARE YARDS PER INCH OF PATCHING IN WORK ORDER

D = TONS OF TYPE B OR C PATCHING IN WORK ORDER

E = NUMBER OF UTILITY ADJUSTMENTS IN WORK ORDER

T = TIME ALLOWED TO PERFORM JOB ORDER ROUNDED UP TO THE NEXT WHOLE WORKING DAY.

**FORMULA:**

$$T = \frac{A}{400TN} + \frac{B}{4000SYIN} + \frac{C}{2200SYIN} + \frac{D}{150TN} + \frac{E}{9EA}$$

**SAMPLE CALCULATIONS:**

A= 1221 TONS

B= 19853 SQUARE YARDS PER INCH

C= 1910 SQUARE YARDS PER INCH

D= 114 TONS

E= 40 EACH

$$T = \frac{1221}{400TN} + \frac{19853}{4000SYIN} + \frac{1910}{2200SYIN} + \frac{114}{150TN} + \frac{40}{9EA}$$

$$T = 3.05 + 4.96 + 0.87 + 0.76 + 4.44$$

$$T = 14.08 = 15 \text{ working days}$$

Daytime restricted hours (Any time frame that is less than eight (8) consecutive daytime hours) may be required on some job orders. The time for these locations shall be increased by Twenty-five percent (for example: 10 working days will become 13 working days).

23. The location of work to be performed will be designated by work order. The City intends to issue work orders so that when one location is completed, the Contractor can immediately move to the next

CITY OF WILMINGTON, DELAWARE  
Public Works Department

---

location. The City will make every attempt to minimize the distance between successive locations. Payment will be made for each work order that requires milling and paving. The Contractor shall be compensated for "Road Location Mobilizations" as defined in Special Provision 763900. Payment for "Road Location Mobilization" will not be made for crack sealing, pavement striping, pavement symbol work or utility adjustments.

24. Sealing of joints between new and existing paving and patches that will not be over laid is required and incidental to the applicable paving and patching items.
25. Butt Joints shall be placed as directed by the Engineer. Butt Joints cut prior to the day of the pavement overlay shall be ramped with hot mix temporary roadway material (TRM).
26. Payment for section 762000 - Saw Cutting, Bituminous Concrete shall be a separate pay item whether or not an overlay is a part of the proposed improvements. Payment for this item will be made only when an approved saw as specified in section 762.3 is used. Cuts made by a milling machine will not be considered for payment under the saw cutting item but are incidental to the milling item.
27. Taper milling when necessary shall be measured as the area taper milled and the average depth of the taper milling shall be used and paid under item 760010 - Pavement Milling Bituminous Concrete Pavement.
28. Removal of material under pay item 402000 (Bituminous Concrete Patching) shall be performed by use of a milling machine, unless directed otherwise by the Engineer. The Engineer may require use of other removal methods for small patching locations, at the sole discretion of the Engineer. The Minimum width for pavement repair is 6 feet, unless directed otherwise by the Engineer.
29. Unless otherwise specified, overlay widths shall match existing widths. The engineer shall provide pavement mark-out that delineates the limits of work at each project location. In full width areas the milling at the edge of the road, curb line or outside edge, shall be 2", the depth at the centerline of the roadway shall be set at 1 ". This is to keep the same curb reveal or improve curb reveal that currently exists. Payment for milling will be based on average depth only. Hot mix patching in these milled areas shall be 3 inches.

In areas where the milling does not extend the full width of the road the milling depth shall be 2" and paid at 2" milling. Any depth beyond 2" shall be paid separately under item 402000 - Bituminous Concrete Patching.

For streets that only require patching, the patching milling depth was calculated at 4". These locations include the placement of 4" of Type B, and/or 2 ½" Type B and 1 ½" Type C. WMA. Patching milling depth may vary depending on existing conditions or as directed by the Engineer. The patching milling at these locations shall be paid under item 402000 - Bituminous Concrete Patching, for the actual depth milled.

30. Milled material shall remain the property of the contractor.
31. Excavated material not needed on the project shall be removed from the site at the Contractor's expense.

CITY OF WILMINGTON, DELAWARE  
Public Works Department

---

32. The Contractor shall take care in removing existing pavement around utilities, curb edges, drainage inlets, and other objects. Care should be taken to not dig deeper than the required depth. Failure to do so will result in Contractor placing leveling course at his own expense.
33. Before the start of pavement removal or patching operations, and where there is existing striping, the Contractor shall be required to provide proof that sufficient material and equipment is available onsite to ensure striping is completed in a timely manner, before traffic is allowed on the roadway.
34. Paving is to be completed curb to curb including turn lanes and intersections within three (3) calendar days of pavement milling for a particular day's roto-milling location. This restriction applies to each day's roto-milling operation, not an entire project location. Failure to comply will result in a suspension of all other contract work with time charges continuing to be assessed. Milled surfaces may/may not be allowed through the weekend on a case-to-case basis at the discretion of the Engineer. All milled surfaces left longer than three days which result in additional failure after initial proof roll and require repair, the repair will be at the Contractor's own expense.
35. Bituminous Concrete Patching shall occur immediately after the milling operation is completed. The milled surface shall be test rolled, by the contractor in the presence of the engineer, using a fully loaded 10-wheel dump truck. All areas marked out by the engineer shall be removed, by the contractor, to a depth 3 inches or as directed by the Engineer. Removal method for bituminous concrete patching shall be by milling machine. Milling for patches will be paid under item 402000 Bituminous Concrete Patching. Backfilling will be performed using item 401029, Superpave, Type B, PG 64-22, Patching. The contractor shall be required to place item 401029, Superpave, Type B, PG 64-22, Patching with a paving machine. Any additional excavation, beyond 3 inches, on an overlay location and 4 inches on a patch location, as may be required by unstable conditions, shall be removed by the contractor. Excavation beyond 3 to 4 inches will be paid under item 202004 Undercut Excavation, Patching when performed as a separate operation. Backfilling of the undercut will be paid using Item 301002 Graded Aggregate Base Course, Type B, Patching or other material as may be directed by the Engineer.
36. All milled patch areas must be backfilled with Superpave Type B, patching the same day. The Type C Hot Mix to be placed the next day, depending on site specific requirements.
37. After pavement milling, all raised edges of manholes, catch basins, water valve boxes, etc. and at milling limits shall be ramped 20:1 with hot mix TRM (Temporary Roadway Material). Such adjustments shall be made prior to opening the road to traffic. Failure to comply will result in a suspension of all other contract work with time charges continuing to be assessed. Payment for TRM shall be made under item 403000. All TRM shall be removed prior to placing hot-mix overlay.
38. All old-style manhole frame and lids as identified in the work order shall be replaced by the contractor with new watertight manhole frame and lids. The contractor shall pick up new manhole frame and lids at the City Maintenance Yard. All replaced frames and lids shall be properly disposed of by the contractor. The cost for pickup of new castings and disposal of old castings to the old castings shall be incidental to item 602132 - Adjust and Repair Existing Manholes.

CITY OF WILMINGTON, DELAWARE  
Public Works Department

---

All water valve boxes shall be adjusted to the new grade. Adjustment risers/collars will be permitted for water valve adjustments and paid under the bid price for item number 710004 - Water Valve Box Riser. Existing water valves are expected to be the three-piece type. An adjustment shall include excavation and unscrewing the top portion of the water valve assembly to the proper grade. If the water valve assembly cannot be unscrewed the entire 3-piece assembly shall be replaced using a Bingham & Taylor, Tyler Company or approved equal, screw top, screw bottom and a 5 ¼ inch drop in water lid valve box. Should replacement of the 3-piece assembly be necessary the replacement costs shall be paid at 1.5 times the bid price for item 710002 - Adjust Water Valve Boxes regardless of depth of the valve. Water valve box assemblies and risers shall be furnished by the contractor.

Extreme care must be taken by the contractor to ensure that the center stones or concrete monuments are not disturbed while adjusting monument boxes. If a center stone or concrete monument is disturbed during construction and installation of a monument box, a registered land surveyor will be required to reset the disturbed center stones or concrete monument at the contractor's expense.

All castings to be adjusted by the contractor as part of this contract shall be raised to the final paving surface elevation. Any casting adjusted higher than the final surface shall be readjusted by the contractor to the correct elevation at no additional cost to the City. Any casting adjusted greater than 1/4 inch below the finish grade shall also be readjusted to within 1/4 inch of the finish elevation at no additional cost to the City. All casting shall be adjusted such that the profile and cross slope shall match the roadway profile and cross slope. Failure to match the profile and cross slope shall result in readjustment at no additional cost to the City. Any hot mix saw cut, excavation, concrete and incidentals necessary for readjustment shall be incidental.

39. Catch basin frames and grates which are not the 45-degree type shall be replaced with a Type 1, Drainage Inlet Grate. The actual locations, the need for any grate modifications, or for new frames and or grates shall be determined by the engineer. The Contractor shall dispose of any replaced frame and grate. All new frames and grates shall be supplied by the Contractor. The cost for installing the new catch basin frame and/or grate shall be paid under item 602100 - Replace Catch Basin Grate(s) and/or 602101 - Replace Catch Basin Frame(s).
40. The Portland Cement Concrete used to make adjustments and or repairs to existing manholes, water valve boxes, monument boxes and lamp holes etc. shall conform to the requirements of Class A concrete as stated within section 503.3.7 of the Department's Standard Specifications. The Portland cement concrete must achieve 2000 psi in 6 hours. The contractor shall protect utility adjustment from traffic until 2000 psi strength of new concrete has been achieved.
41. Section 301002, Graded Aggregate Base Course, Type B, Patching is a contingency item for undercut excavation backfill.
42. All Portland cement concrete must be received from an approved production plant or a DelDOT approved batch truck. No on-site mixtures will be permitted.

CITY OF WILMINGTON, DELAWARE  
Public Works Department

---

43. All water shall be contractor supplied from water trucks. The use of hydrants by the contractor for a water supply shall only be permitted in an emergency and only with an approved City Hydrant Permit.
44. The contractor shall provide and maintain an adequate number of toilets on site. Toilet facilities shall be the enclosed chemical type.
45. The contractor is reminded that section 105.7 of the standard specifications requires the general contractor to have a competent superintendent or foreman on the project at all times.
46. The Contractor shall provide residents 72-hour prior written notice for all phases of contract work including but not limited to: milling, utility adjustments, patching and paving. This notice shall be given to all residents whose property is adjacent to the street on which work is to be performed. This will be accomplished by the contractor preparing and distributing a standard form letter to all residents and businesses in and about the area of work. This letter will be subject to approval by the engineer. Failure to give notice will result in suspension of work, until proper notice is provided.
47. The contractor shall post "No Parking signs" 48 hours prior to starting work at a work location. "No parking signs" will be supplied to the contractor by the Department of Public Works at no cost to the contractor. Failure to post the no parking signs 48 hours in advance of work will result in a suspension of work requiring notice until proper notice is provided. The No Parking Signs shall include dates the street will be closed. No Parking signs shall be placed on drums at a minimum spacing of fifty feet on the project location, both sides of the roadway. Placement on utility poles, trees, construction cones or stakes will not be permitted and will cause unnecessary scheduled delays. The Contractor shall include the dates prior to posting. Should scheduled work be delayed, by rain or other factors beyond the control of the contractor, AFTER No Parking Signs have been posted the contractor shall notify the Engineer of the postponed work and shall immediately change the date contained on the No Parking Signs to the rescheduled work date.
48. The contractor is reminded that section 108.4 of the standard specifications requires "a proposed activity schedule" for the following two-week period. This activity schedule shall reflect specific details related to actual construction activities that the contractor plans to have in progress during this two-week period. This activity schedule is to be submitted to the engineer no later than noon of each Thursday. Failure to comply will result in a suspension of all contract work with time charges continuing to be assessed. An excel spreadsheet showing locations type of work and dates will be required. The two-week schedule shall include detour routes if the detour routes have been approved by the City. This scheduled will be reviewed by the Engineer and distributed to City personnel. The contractor is also reminded to report the work locations to the City's Traffic Advisory Collector as a requirement for this project. A link to the Traffic Advisory Collector App is: <http://wilmingtonde.maps.arcgis.com/apps/webappviewer/index.html?id=6cf932b9a8f641ba83a8d99c3bf3fb4b>. Failure to do so will result in a suspension of work with time charges continuing to be assessed.
49. Inlet sediment control (ISC) devices shall be placed in all drainage inlets within construction limits prior to the milling of the location and promptly removed once the final paving has been completed. Operations shall be halted if ISC devices are not in place prior to the start of milling or until all ISC devices are placed. During the removal of the ISC device, the contractor will take extreme care as to

CITY OF WILMINGTON, DELAWARE  
Public Works Department

---

not dump any material in the drainage inlet. The installation and removal of shall be paid under the unit bid price for item 905004, Inlet Sediment Control, Drainage Inlets. ISC devices shall be reused on other locations and paid under the unit bid price for item 905004-A, Reuse Inlet Sediment Control, Drainage Inlets. In the event that an ISC device cannot be reused due to damage or wear, the contractor must show the engineer prior to the implementation of a new device. Any construction material that gets in the inlet must be removed prior to contractor starting the next location or operations could be halted and time charges will continue.

All manholes shall be securely covered prior to the day's operations in order to prevent debris from entering the sewer system. Operations shall be halted if manholes are not protected as directed by the engineer. Contractor is responsible for removal of any debris that may enter the manhole. Confined space requirements apply for any work associated with the removal of this material.

50. TREES SHALL NOT BE INJURED DURING ANY CONSTRUCTION OPERATION. This includes damage to the tree roots. Material shall not be stockpiled within the drip line of any tree. The contractor shall review the area to be milled and paved with regard to tree branches that are in the way of the milling and paving operations. The contractor shall trim branches, under the direction of the City's Forestry Department, that are obviously in the way of these operations and will be damaged if not removed. In the event that existing trees are unintentionally damaged the contractor shall immediately notify the City to determine if the tree can be treated. If not and removal is required then replacement with two (2) young trees at the Contractors' expense is required as per City Code § 46-32 Section E.
51. At the end of each workday and before traffic is returned to unrestricted roadway use, temporary striping shall be placed at all locations that require permanent striping. Placement of temporary markings shall receive prior approval from the Engineer. Temporary pavement markings shall be paid at the applicable contract unit price. The Contractor is responsible for maintaining the temporary markings in good condition, such that the pavement is properly delineated at all times. Any refreshing of the markings will be at the Contractor's expense. Payment for temporary pavement striping shall be made at the unit price bid for item 817003 - Temporary Markings, Paint, 4". Payment for final striping will be included in the applicable striping item.
52. All stop lines "bars" shall be installed in accordance with section 3B.16 of the 2011 Delaware MUTDC.

All crosswalks shall be installed in accordance with section 3B.16 of the 2011 Delaware MUTDC. International crosswalk symbols shall be placed at locations directed by the Engineer and shall be paid under item 817002 - Permanent Pavement Striping, Sym/Leg Alkyd Thermoplastic.

At the end of each day's operation and before traffic is returned to unrestricted roadway use, temporary striping shall be utilized at locations that require permanent striping, when:

- A. existing pavement is milled and hot mix will not be placed the same day;
- B. more than a single course of hot mix is to be placed;
- C. permanent roadway striping cannot be placed on the same day as the placement of the final course of hot mix.

CITY OF WILMINGTON, DELAWARE  
Public Works Department

---

53. Final pavement markings shall conform to all existing patterns and shall be placed within five (5) calendar days after placement of the final course of paving material. Failure to comply will result in suspension of all contract work, with time charges continuing to be assessed. If the Contractor fails to document the existing pavement markings in an acceptable manner, he/she shall be required to provide at his own expense, a new pavement marking plan, signed and sealed by a Professional Engineer in the State of Delaware.
54. The crack seal item is intended to be used on any patching locations and other locations that may be directed by the Engineer. Crack sealing required under the 401 items remains incidental to those items of work, with no separate payment being made.
55. The contractor and all others shall perform all work in a manner that will ensure the least practical obstruction to the traveling public and shall conform to the requirements of the 2011 Delaware Manual on Uniform Traffic Control Devices (MUTDC) including the latest versions to the manual in effect at the time of advertisement for bids and as detailed in Item, 801500 - Maintenance of Traffic, All Inclusive.
56. "Contractor shall provide insurance coverage for itself and all of its employees, if any, used in connection with this Agreement as follows: workers compensation as required by law; comprehensive general liability coverage for personal injury, including death, and property damage in the minimum amount of One Million Dollars (\$1,000,000.00). Such policies shall be issued by a financially sound carrier and/or carriers and shall be subject to the reasonable approval of the City. Contractor shall provide the City with a certificate of insurance evidencing the above-stated coverage and naming the City as an additional insured."

# **PREVAILING WAGES**

**CITY OF WILMINGTON, DELAWARE  
DEPARTMENT OF PUBLIC WORKS  
STREET PAVING, PHASE X**



STATE OF DELAWARE  
DEPARTMENT OF LABOR  
DIVISION OF INDUSTRIAL AFFAIRS  
OFFICE OF LABOR LAW ENFORCEMENT  
PHONE: (302) 761-8200

Mailing Address:  
4425 North Market Street  
3rd Floor  
Wilmington, DE 19802

Located at:  
4425 North Market Street  
3rd Floor  
Wilmington, DE 19802

PREVAILING WAGES FOR HIGHWAY CONSTRUCTION EFFECTIVE MARCH 15, 2021

CLASSIFICATION	NEW CASTLE	KENT	SUSSEX
BRICKLAYERS	60.24	60.24	58.65
CARPENTERS	57.77	57.31	45.55
CEMENT FINISHERS	60.00	36.80	29.26
ELECTRICAL LINE WORKERS	30.30	48.95	23.95
ELECTRICIANS	74.70	74.70	74.70
IRON WORKERS	73.74	26.90	28.57
LABORERS	46.69	42.97	42.18
MILLWRIGHTS	18.16	17.62	15.22
PAINTERS	75.29	75.29	75.29
PILEDRIVERS	81.12	26.78	30.37
POWER EQUIPMENT OPERATORS	69.92	44.64	40.90
SHEET METAL WORKERS	25.65	22.89	20.73
TRUCK DRIVERS	43.94	31.83	38.77

CERTIFIED:

03/15/2021

BY:

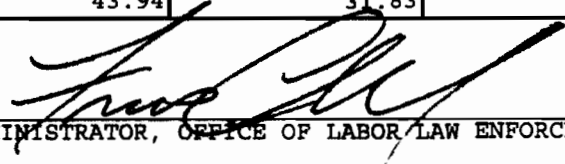

ADMINISTRATOR, OFFICE OF LABOR LAW ENFORCEMENT

**NOTE:** THESE RATES ARE PROMULGATED AND ENFORCED PURSUANT TO THE PREVAILING WAGE REGULATIONS ADOPTED BY THE DEPARTMENT OF LABOR ON APRIL 3, 1992.

CLASSIFICATIONS OF WORKERS ARE DETERMINED BY THE DEPARTMENT OF LABOR. FOR ASSISTANCE IN CLASSIFYING WORKERS, OR FOR A COPY OF THE REGULATIONS OR CLASSIFICATIONS, PHONE (302) 761-8200.

NON-REGISTERED APPRENTICES MUST BE PAID THE MECHANIC'S RATE.

THESE RATES ARE BEING PROVIDED IN ACCORDANCE WITH DELAWARE'S FREEDOM OF INFORMATION ACT.

THEY ARE NOT INTENDED TO APPLY TO ANY SPECIFIC PROJECT.

# **HYDRANT PERMIT**

**CITY OF WILMINGTON, DELAWARE  
DEPARTMENT OF PUBLIC WORKS  
STREET PAVING, PHASE X**

**DEPARTMENT OF PUBLIC WORKS**

*Louis L. Redding-City/County Building  
800 French Street, 6<sup>th</sup> Floor  
City of Wilmington, Delaware 19801  
302-576-3063 (Office) 302-571-4579 (Fax)*

**HYDRANT PERMIT**

DATE PERMIT ISSUED: \_\_\_\_\_

\_\_\_\_\_  
**(NAME OF COMPANY/ORGANIZATION, etc)**

Permission is granted from the City of Wilmington Department of Public Works Water Division to utilize the fire hydrant(s) located:

\_\_\_\_\_

For a period of: \_\_\_\_\_

Beginning: \_\_\_\_\_ through: \_\_\_\_\_

for the purpose of: \_\_\_\_\_

**APPROXIMATE AMOUNT OF WATER USAGE FOR ENTIRE PROJECT:** \_\_\_\_\_ gallons

**(ABOVE LINE MUST BE COMPLETED)**

The user of the hydrant will pay a cost of \$ \_\_\_\_\_ for water usage, and **\$75 for use of designated fire hydrant.**

An additional deposit of \$50.00 is required if user requests the use of a hydrant wrench and/or adapter, which must be returned by: \_\_\_\_\_. Anyone failing to return loaned equipment will lose this privilege for future use, and will be billed for full costs for replacement of equipment not returned.

**MUST POSSESS COPY OF THIS PERMIT DURING USE OF FIRE HYDRANT**

\_\_\_\_\_  
Water Systems Supervisor or Designated Representative  
Department of Public Works, Water Division

\_\_\_\_\_  
Signature of Person Obtaining Permit

\_\_\_\_\_  
Title

\_\_\_\_\_  
Company Address: \_\_\_\_\_

\_\_\_\_\_

\_\_\_\_\_  
Office Number

\_\_\_\_\_  
Fax Number

**Fire Hydrant Use Guidelines received. User agrees to adhere to guideline** \_\_\_\_\_  
Initial

**Bottom of permit must be completed if filling a tank from fire hydrant.**

Tank fill up Time(s): \_\_\_\_\_ (am) and/or \_\_\_\_\_ (pm)  
(Number) \_\_\_\_\_ time(s) per (Day/Week) \_\_\_\_\_

**Time(s) listed shall remain the same, and will be enforced by WD Inspectors during duration of permit.**

**DEPARTMENT OF PUBLIC WORKS  
CITY OF WILMINGTON WATER  
Guidelines for Users of City of Wilmington Fire Hydrants**

1. Use of fire hydrant for the sole purpose as described on hydrant permit; or for the sole purpose of watering landscape for the City of Wilmington's Beautification Program. Watering will be permitted between the hours of 5:00 a.m. and 8:00 a.m., and between 5:00 p.m. and 8:00 p.m. during period indicated on permit.
2. The City of Wilmington has granted you permission to operate only the hydrant(s) that are indicated on the attached permit during said period. If filling a tank, advise WD personnel time(s) of day (am/pm) tank will be filled. Time(s) listed shall remain the same, and will be enforced for the duration of the permit.
3. Operation of a City of Wilmington fire hydrant is by utilizing a TWO INCH HOSE, and a HYDRANT WRENCH ONLY to rotate the operating nut to allow the flow of potable water. The operating nut shall be turned on SLOWLY to the FULL OPEN OR TURNED OFF SLOWLY to the FULL CLOSED position.
4. User is responsible for any/all equipment loaned, which must be returned by the indicated period on the permit. Failing to return equipment will subject user to replacement costs and/or loss of privileges for future use of equipment.
5. The City is unable to regulate the flow of water through the hydrants; and therefore, the user agrees that no claim will be made against the City for damages as a result of pressure of water. User also agrees to indemnify and hold the City harmless from any and all liability for damages or injuries (including death) to any person or property whatsoever arising from or occasioned by the installation, operation, and removal of the adapter in operation of the fire hydrant.
6. The City, at its sole discretion, may terminate user's privilege of operation designated fire hydrants; and in the event of any emergency situation as determined by the City, the City shall have the right to restrict, partially or fully, the quantity of water utilized by user through the City's hydrants without any prior notification.
7. If fire hydrant is inoperable, immediately contact our Service Division at (302) 576-3877 to advise, and request approval for use of a hydrant at another designated location.

# **DETAILS**

**CITY OF WILMINGTON, DELAWARE  
DEPARTMENT OF PUBLIC WORKS  
STREET PAVING, PHASE X**

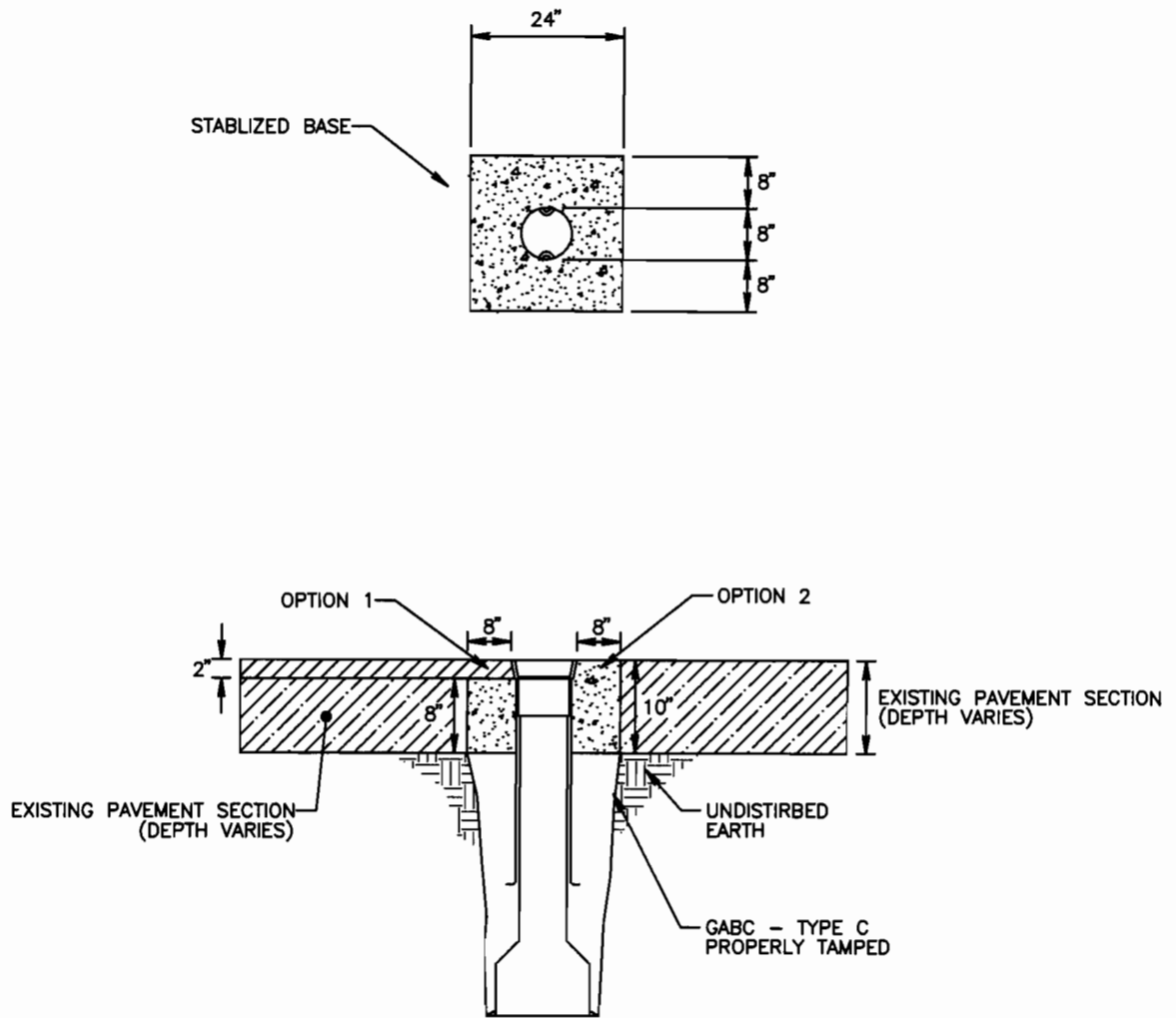

NOTES:

EXISTING MATERIAL CAN BE REUSED AS BACKFILL MATERIAL UNLESS OTHERWISE DIRECTED BY THE ENGINEER.

CONCRETE USED SHALL CONFORM TO SECTION 503.02.

VALVE BOX ADJUSTMENT DETAIL

NO SCALE

DETAIL 2

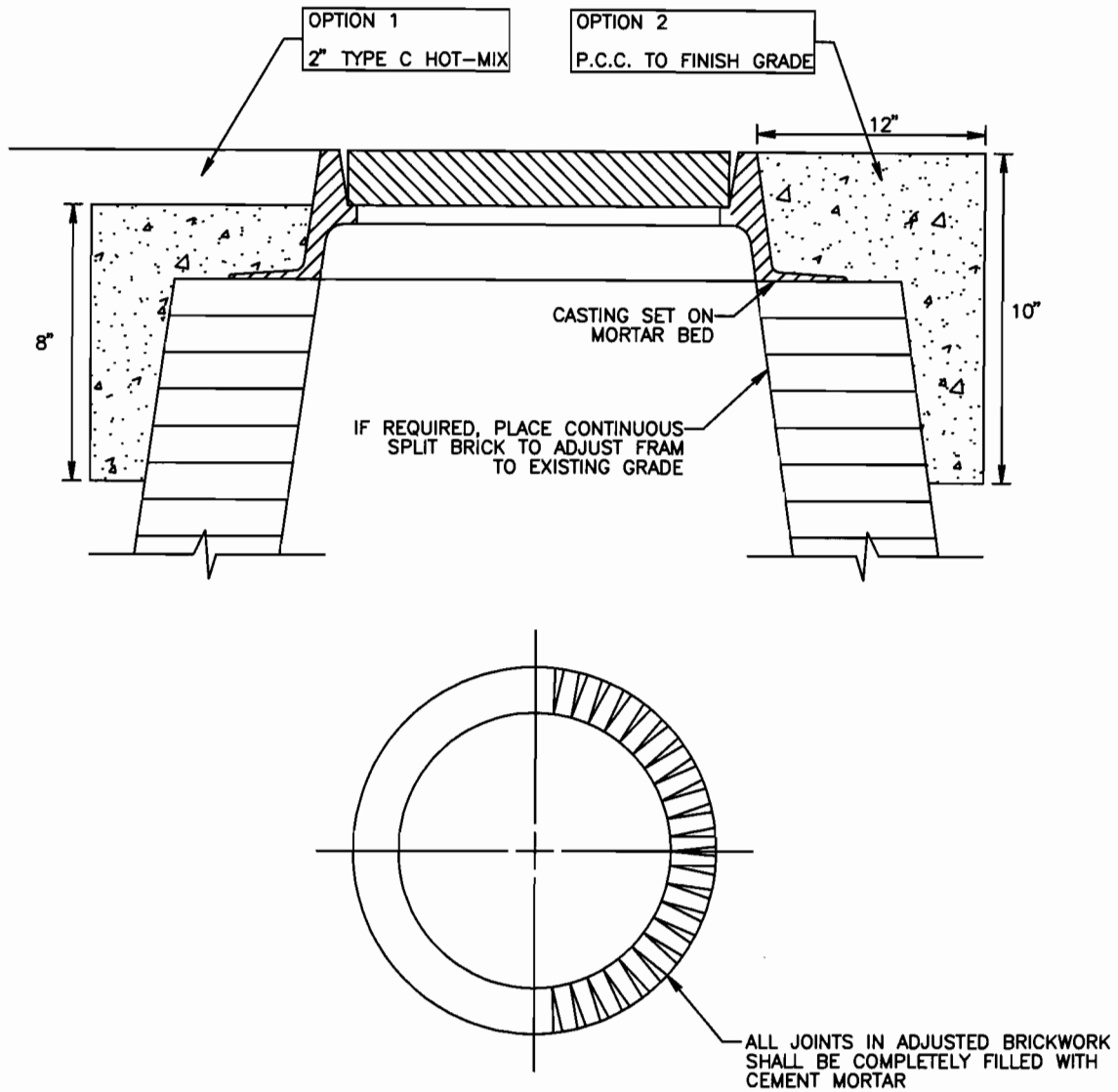

### ADJUSTING AND REPAIRING MANHOLE

NOTE:  
 REMOVE AND DISPOSED OF EXISTING FRAME AND COVER AS DIRECTED BY ENGINEER IF NOT UTILIZED IN THE ADJUSTMENT. PLACE NEW FRAME AND COVER SUPPLIED BY OWNER TO CORRECT ELEVATION AND RESET USING MORTAR AND BRICK. SAW CUTTING FULL DEPTH IS REQUIRED AND IS INCIDENTAL TO ITEM 710002. REPAIR MASONRY FOUND TO BE IN POOR CONDITION AS DIRECTED BY THE ENGINEER. CONCRETE USED TO ADJUST AND REPAIR EXISTING MANHOLES AS PER SECTION 503.02. CASTING SHALL BE FLUSH IN PROFILE AND CROSS SLOPE WITH NEW PAVEMENT GRADES.

### MANHOLE ADJUSTMENT DETAIL

NO SCALE

DETAIL 3

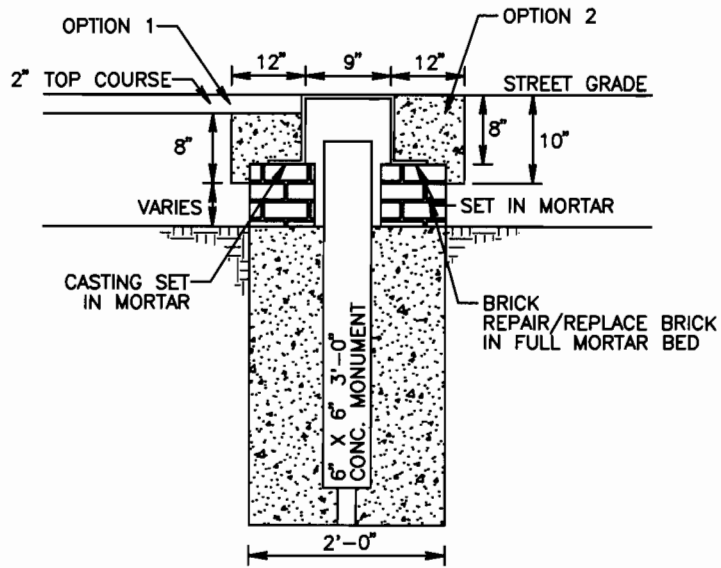
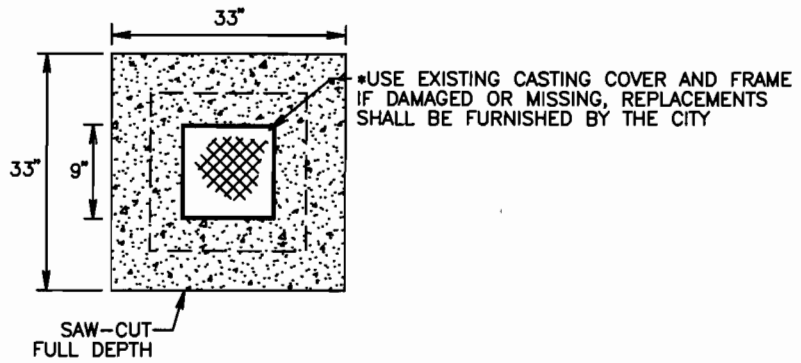

NOTE:  
DO NOT DISTURB MONUMENT. IF MONUMENT IS DISTURBED DURING ADJUSTMENT IT SHALL BE RESET BY A DELAWARE PROFESSIONAL LAND SURVEYOR (PLS) AT CONTRACTORS EXPENSE. CONCRETE AS PER SECTION 503.02.

MONUMENT BOX ADJUSTMENT DETAIL

NO SCALE



# **SPECIAL PROVISIONS**

**CITY OF WILMINGTON, DELAWARE  
DEPARTMENT OF PUBLIC WORKS  
STREET PAVING, PHASE X**

## **401502 - ASPHALT CEMENT COST ADJUSTMENT**

For Sections 304, 401, 402, 403, 404, and 405, payments to the Contractor shall be adjusted to reflect increases or decreases in the Delaware Posted Asphalt Cement Price when compared to the Project Asphalt Cement Base Price, as defined in these Special Provisions.

The Delaware Posted Asphalt Cement Price will be issued monthly by DelDOT and will be the industry posted price for Asphalt Cement, F.O.B. Philadelphia, Pennsylvania. The link for the posting is [http://www.deldot.gov/information/business/bids/asphalt\\_cement\\_english.shtml](http://www.deldot.gov/information/business/bids/asphalt_cement_english.shtml).

The Project Asphalt Cement Base Price will be the Delaware Posted Asphalt Cement Price in effect on the date of advertisement.

All deviations of the Delaware Posted Asphalt Cement Price from the Project Asphalt Cement Base Price are eligible for cost adjustment. No minimum increases or decreases or corresponding percentages are required to qualify for cost adjustment.

Actual quantity of asphalt cement qualifying for any Asphalt Cement Cost Adjustment will be computed using the weight of eligible asphalt that is shown on the QA/QC pay sheets as a percentage for the delivered material.

If the mix was not inspected and no QA/QC pay sheet was generated, then the asphalt percentage will be obtained from the job mix formula for that mix ID.

The asphalt percentage eligible for cost adjustment shall only be the virgin asphalt cement added to the mix.

There shall be no separate payment per ton cost of asphalt cement. That cost shall be included in the various unit prices bid per ton for those bid items that contain asphalt cement (mentioned above).

The Asphalt cement cost adjustment will be calculated on grade PG 64-22 asphalt regardless of the actual grade of asphalt used. The Project Asphalt Cement Base Price per ton for the project will be the Delaware Posted Asphalt Cement Price in effect on the date of project advertisement.

If the Contractor exceeds the authorized allotted completion time, the price of asphalt cement on the last authorized allotted work day, shall be the prices used for cost adjustment during the time liquidated damages are assessed. However, if the industry posted price for asphalt cement goes down, the asphalt-cement cost shall be adjusted downward accordingly.

### **NOTE:**

Application of Asphalt Cement Cost Adjustment requirements as indicated above shall apply only to those contracts involving items related to bituminous base and pavements, and with bitumen, having a total of 1,000 tons or more of hot-mix bid quantity in case of Sections 401, 402 and 403; and 15,000 gallons or more in case of Sections 304, 404 and 405.

5/05/15

## **401699 - QUALITY CONTROL/QUALITY ASSURANCE OF BITUMINOUS CONCRETE**

### **.01 Description.**

This item shall govern the Quality Control/Quality Assurance Testing for supplying hot-mix asphalt plant materials and constructing hot-mix asphalt pavements.

The Contractor shall be responsible for providing the quality level of materials and construction incorporated into the Contract that will meet the requirements of the Contract. The Contractor shall perform all necessary quality control inspection, sampling, and testing. The Engineer will evaluate all materials and construction for acceptance. The procedures for Quality Control and Acceptance are described in this Section.

**Compacting testing shall be performed by the contractor using a nuclear testing gauge or other approved testing device. Cores shall only be taken if results of the nuclear testing results are in the penalty range of this specification or if directed by the Engineer. Material testing shall be performed by the contractor and reported to the engineer on a daily basis. All compaction testing shall be performed by the contractor, and reported to the engineer.**

**The Contractor shall be responsible for performing all quality assurance testing of materials and compaction as described in this specification and reporting the results to the Engineer. Payment will be based on the Contractors results unless separate information is obtained by the Engineer that conflicts with the Contractors results. The dispute resolution porting of this specification will apply in this case. The bonus portion of this specification has been eliminated.**

### **.02 Definitions.**

- **Acceptable Quality Level (AQL):** That level of percent within limits (PWL) to which the Engineer will consider the work completely acceptable.
- **Acceptance Plan:** Factors that comprise the Engineer's determination of the degree of compliance with contract requirements and value of the product. These factors include the Engineer's sampling, testing, and inspection.
- **Delaware Asphalt Pavement Association (DAPA):** The organization representing the interests of hot-mix asphalt producers and Contractors. The Engineer has a copy of the DAPA officers' names and point(s) of contact.
- **Dispute Resolution:** The procedure used to resolve conflicts resulting from discrepancies between the Engineer's and the Contractor's results of sufficient magnitude to impact payment. The testing will take place at a location and time mutually agreeable by both the Engineer and the Contractor.
- **Full Depth Construction -** Construction of an adequate pavement box on a subgrade and subbase prepared by the contractor
- **Independent Assurance:** An unbiased and independent verification of the Quality Assurance system used, and the reliability of the test results obtained in regular sampling and testing activities. The results of Independent Assurance are not to be directly used as a basis of material acceptance.
- **Job Mix Formula (JMF)/Mixture Identification (ID):** The target values for individual aggregate size gradation percentages and the asphalt percentage, the sources of each of the component materials, the proposed proportions of component materials to be used to meet those

target values, the asphalt proportion, and the mixing temperature. The Engineer will assign uniquely individual mixture identification for each JMF submitted and approved.

- **Lower Quality Index (QL):** The index reflecting the statistic related to the lower boundary to which a sample (or sample statistic) may deviate from the target value and still be considered acceptable.
- **Mean:** A statistical measure of the central tendency - the average value.
- **Operational Day:** A day in which the Engineer has approved a lane closure for the Contractor to perform work within an approved MOT plan.
- **Percent Within Limits (PWL):** That amount of material or workmanship that has been determined, by statistical method, to be within the pre-established characteristic boundary(ies).
- **Qualified Laboratory:** A laboratory mutually agreed upon by both DAPA and the Engineer as having proper test equipment that has been calibrated in accordance to AASHTO.
- **Qualified Technician:** Personnel mutually agreed upon by both DAPA and the Engineer as having adequate training, experience, and abilities to perform the necessary testing. The minimum qualifications are either a recognized nationally accredited or certified Superpave testing certificate or been working in hot-mix asphalt testing for at least one year.
- **Quality Assurance (QA):** All those planned and systematic actions necessary to provide adequate confidence that a product or service will satisfy given requirements for quality.
- **Quality Control (QC):** The sum total of the activities performed by the Contractor in order to assure that the product meets contract requirements.
- **Quality Control (QC) Plan:** The detailed description of the type and frequency of inspection, sampling, and testing deemed necessary to measure and control the various properties governed by the Specifications. The QC Plan must address the actions needed to keep the process in control, detect when the process is going out of control, and responses to correct the situation(s).
- **Quality Level Analysis:** A statistical procedure that provides a method for estimating the percentage of each lot or subplot of material, product, item of construction, or completed construction that may be expected to be within specified tolerances.
- **Standard Deviation:** A term used in statistics to indicate the value calculated from the square root of the difference between the individual measurements in a group and their average. Standard deviation is calculated by taking the square root of the sum of the squares of the differences of each of n values and the mean value, this sum first divided by (n-1).
- **Target Value:** The acceptable value for a controlling characteristic of a product. The JMF will establish each of these values for the material.
- **Test Methods:** Shall be AASHTO test methods. Copies of these test methods shall be available at each qualified laboratory.
- **Upper Quality Index (QU):** The index reflecting the statistic related to the upper boundary to which a sample (or sample statistic) may deviate from the target value and still be considered acceptable.
- **Volumetric Properties:** Air voids, voids in mineral aggregates (VMA), voids filled with asphalt (VFA), and dust to effective asphalt.

### **.03 Equipment.**

#### **(a) Material Production Test Equipment.**

The Contractor shall establish, maintain, and operate a qualified testing laboratory at the production plant site of sufficient size and layout that will accommodate the testing operations of both the Contractor and the Engineer. The Contractor shall maintain all the equipment used for handling, preparing, and testing materials in proper operating condition. For any laboratory equipment malfunction,

the Contractor shall remedy the situation within one working day or the Engineer may reject production. In the case of an equipment malfunction, and while waiting for repairs to equipment, the Engineer may elect to test the material at either another production facility or the Engineer's laboratory to obtain payment factors.

The following shall be the minimum calibrations for the referenced equipment:

- SUPERPAVE<sup>R</sup> Gyratory Compactor: once every year; verified once every month.
- Ovens: once every three months, verified once every month.
- Vacuum Container and Gauge (Rice Bowls): once every three months, verified once every month.
- Balances and Scales: once every year, verified once every month.
- Thermometers: once a year; verified once every month.
- Gyratory Compactor molds and base plates: once every year
- Mechanical Shakers: once every year
- Sieve Verifications: once every year

All calibrations shall be documented and on file for review by the Engineer at any time.

**(b) Pavement Construction Test Equipment.**

The Contractor shall furnish and use in-place density gauges, or coring equipment, or both, as necessary to meet the requirements of these Specifications.

**.04 Quality Control (QC) Plan.**

**(a) Material Production QC.**

**(1) Job Mix Formula - Material Production.**

The Contractor shall submit for approval to the Engineer the job mix formula (JMF) design of the component materials and target characteristic values for each mixture proposed for use. Once the JMF is submitted to the Engineer, the Engineer will have up to three weeks to review the submitted information. The Contractor shall only submit for approval a Del DOT approved JMF. After that approval from the Engineer, the Contractor shall produce the new mixture. The Contractor will test the material, by taking three series per the specifications. If the Contractor's test results are within the specifications, then the mixture will be approved by the Engineer for City projects.

The component materials design shall include designating the source and the expected proportion (within 1 percent for the aggregate components, and within 0.1 percent for the other components) of each component to be used in order to produce workable hot-mix asphalt having the specified properties. For plant component feed adjustments, RAP can be considered in the same manner as an individual aggregate component. The JMF target characteristic values include the mixing temperature range, core temperature range for gyration, the percentage of the asphalt cement component (both total and virgin), and the percentages of the aggregate amounts retained on the sieves to be addressed by the JMF as shown in Table 1.

The Contractor shall provide an ignition oven correction number for each JMF. The Contractor shall also supply to the Engineer weighed material of each JMF so correction numbers can be established for the Engineer's equipment for Dispute Resolution samples.

Prior to starting production of a new mixture, the Contractor shall submit a JMF. For any mixture that has a 20% or greater failure rate on any combined volumetric criteria, the JMF will not be approved for use on Department contracts. In order to be approved, a re-design of the mixture will have to be completed by the Contractor for review and approval by the Engineer. The Contractor shall uniquely title each JMF. The Contractor shall submit test data with each JMF and tests performed by a Qualified Laboratory on representative materials, verifying the adequacy of the design. Refer to the specifications for each mix type in order to determine the design requirements. The JMF sieve percentage values shall conform to the ranges shown in Table 1.

If there is a change in the source of any of the component materials, other than asphalt, if there is a change in the proportions of the aggregate components or the percent passing for each sieve by more than 5 percent from the submitted JMF, or if there is a change in the percentage of the asphalt cement component by 0.2 percent or more, which causes the volumetrics to change from the originally submitted JMF, a new JMF is required. Also, if the asphalt cement target percentage is lowered, all volumetric criteria must still be achieved.

According to the Contractor's QC Plan, the Contractor shall inform the Engineer of any proposed changes to an existing JMF. The Contractor shall notify the Engineer by electronic mail of the proposed changes. The Engineer will reply to the proposed changes within one operational day and notify the Contractor of the effective date of the changes.

Although a new JMF is not required, the Contractor must notify the Engineer of any change in the proportions of the components. This notification shall include the total change made from the approved JMF proportions, and the effective time of the change.

All submitted JMF's shall correspond to the Pinepave mixture design software. The Engineer, for evaluation of the submitted JMF, will use the first three test samples. These test results acquired during production shall be within the following range compared to the submitted JMF on the Pinepave mixture design software:  $G_{mm}$ : + / - 0.030 and  $G_{mb}$ : + / - 0.040

<b>Table 1 - Aggregate Gradation - JMF and Control Point Information</b>										
<b>Sieves to be addressed by JMF/Range values are percentages passing by weight</b>										
<b>Sieve Size mm (inch)</b>	<b>4.75 mm</b>	<b>4.75m m Range</b>	<b>9.5 mm</b>	<b>9.5mm Range</b>	<b>12.5 mm</b>	<b>12.5mm Range</b>	<b>19.0 mm</b>	<b>19.0mm Range</b>	<b>25.0 mm</b>	<b>25.0mm Range</b>
37.5(1.5)	No		No		No		No		Yes	100
25.0(1.0)	No		No		No		Yes	100	Yes	90-100
19.0 (3/4)	No		No		Yes	100	Yes	90-100	Yes	20-90
12.5(1/2)	Yes	100	Yes	100	Yes	90-100	Yes	23-90	Yes	
9.5 (3/8)	Yes	95-100	Yes	90-100	Yes	28-90	Yes		Yes	
4.75(#4)	Yes	90-100	Yes	32-90	Yes		Yes		Yes	

**Table 1 - Aggregate Gradation - JMF and Control Point Information**

Sieves to be addressed by JMF/Range values are percentages passing by weight										
Sieve Size mm (inch)	4.75 mm	4.75m m Range	9.5 mm	9.5mm Range	12.5 mm	12.5mm Range	19.0 mm	19.0mm Range	25.0 mm	25.0mm Range
2.36(#8)	Yes		Yes	32-67	Yes	28-58	Yes	23-49	Yes	19-45
(#16)	Yes	30-60	Yes		Yes		Yes		Yes	
(#30)	Yes		Yes		Yes		Yes		Yes	
(#50)	Yes		Yes		Yes		Yes		Yes	
(#100)	Yes		Yes		Yes		Yes		Yes	
.075(#20 0)	Yes	6-12	Yes	2-10	Yes	2-10	Yes	2-8	Yes	1-7

**(2) Process Control - Material Production.**

The Contractor shall submit in writing (letter or electronic mail) a QC Plan from each proposed production plant to the Engineer; no hot-mix asphalt material will be accepted until the Engineer approves the QC Plan. This plan must be submitted to the Engineer on an annual basis for review and approval prior to material production. The Engineer will send a signed copy back to the Contractor stating that it is approved. The approved QC Plan shall govern contractor operations.

The following are considered significant violations to the Contractor's QC Plan:

- Using testing equipment that is knowingly out of calibration or is not working properly.
- Reporting false information such as test data, JMF information, or any info requested by the Engineer.
- When the Contractor fails to comply to their approved QC Plan in reference to materials testing
- Substantial deviations to AASHTO or DelDOT procedures when running tests, sampling stockpiles, or testing hot mix.
- The use of any material not listed in the JMF.
- The use of the wrong PG graded asphalt.
- If samples fall within the Contractors action points in the QC Plan but the Contractor fails to take the corrective action in the approved QC Plan

If a Contractor is found in violation of any of these items, they will receive a written warning for their first violation. If the Contractor is found in violation a second time on any of the criteria, they will forfeit any bonus from that day's production. If the Contractor is found in violation a third time on any of the criteria, they will receive a five percent (5%) deduction for that day's production. If the Contractor is found in violation a fourth time, the plant will not be approved for production until such time that the Contractor addresses the violation of the QC plan to the satisfaction of the Engineer. If the Engineer

approves the changes in advance, the Contractor may make changes to the QC Plan. All changes shall be submitted and approved in writing by the Engineer.

The QC Plan shall include actions that will assure all materials and products will conform to the specifications, whether manufactured or processed by the Contractor, or procured from suppliers, subcontractors, or vendors. The Contractor shall perform the inspection and tests required to substantiate product conformance to contract requirements. The Contractor shall document QC inspections and tests, and provide copies to the Engineer when requested. The Contractor shall maintain records of all inspections and tests for at least one year. The records shall include the date, time, and nature of deficiency or deficiencies found; the quantities of material involved until the deficiency was corrected; and the date, time, and nature of corrective actions taken.

In the QC Plan, the Contractor shall detail the type and frequency of inspection, sampling, and testing deemed necessary to measure and control the various properties of material and construction governed by the Specifications. The QC Plan shall include the following elements as a minimum:

- Production Plant - make, type, capacity, and location.
- Production Plant Calibration - components and schedule; address documentation.
- Personnel - include name and telephone number for the following individuals:
  - Person responsible for quality control.
  - Qualified technician(s) responsible for performing the inspection, sampling, and testing.
  - Person who has the authority to make corrective actions on behalf of the Contractor.
- Testing Laboratory - state the frequency of accuracy checks and calibrations of the equipment used for testing; address documentation.
- Locations where samples will be obtained and the sampling techniques for each test
- Load number of QC samples (1-10 if QA sample is not within trucks 1-10)
- Tests to be performed and their normal frequency; the following, at a minimum, shall be conducted:
  - Mixture Temperature: each of the first five trucks, and each load that is sampled for QC or acceptance testing.
  - Gradation analysis of aggregate (and RAP) stockpiles - one washed gradations per week for each aggregate stockpile; RAP: five gradations and asphalt cement contents for dedicated stockpiles where new material is not being added; one gradation and asphalt cement content test per week for stockpiles where material is continually being added to the stockpile.
  - Gradation analysis of non-payment sieves
  - Dust to effective asphalt calculation
  - Moisture content analysis of aggregates B daily.
  - Gradation analysis of the combined aggregate cold feed - one per year per mixture.
  - Bulk specific gravity and absorption of blended material - one per year per mixture.
  - Ignition Oven calibration - one per year per mixture.
  - Hot-Bins: one per year per mixture.
  - Others, as appropriate.
- Procedures for reporting the results of inspection and tests (include schedule).



- Procedures for dealing with non-compliant material or work.
- Presentation of control charts. The Contractor shall plot the results of testing on individual control charts for each characteristic. The control charts shall be updated within one working day as test results for each subplot become available. The control charts shall be easily and readily accessible at the plant laboratory. The following parameters shall be plotted from the testing:
  - Asphalt cement content.
  - Volumetrics (air voids, voids in mineral aggregates [VMA])
  - Gradation values for the following sieves:
    - 4.75 mm (#4).
    - 2.36 mm (#8).
    - 0.075 mm (#200).
- Operational guidelines (trigger points) to address times when the following actions would be considered:
  - Increased frequency of sampling and testing.
  - Plant control/settings/operations change.
  - JMF adjustment.
  - JMF change (See Section .04(a)(1)).
  - Change in the source of the component materials.
  - Calibration of material production equipment (asphalt pump, belt feeders, etc.).
  - Rejection of material.

When any point of non-compliance with the QC plan, or material not meeting the Specifications, comes to the attention of either the Contractor or the Engineer, the other party shall be notified immediately, and the Contractor shall take appropriate corrective actions. Failure to take corrective actions immediately shall be cause for rejection of material or work by the Engineer.

**(b) Pavement Construction - Process Control.**

The Contractor shall perform Quality Control of pavement compaction by testing in-place pavement with a density gauge or by testing cores extracted from the pavement. The use of the nuclear density gauge shall conform to ASTM D2950; the use of other density gauges shall be as per the manufacturer's recommendations and approved by the Engineer. The Contractor may use any method to select locations for the Quality Control.

**.05 Acceptance Plan.**

**(a) Material Production - Tests and Evaluations.**

The Engineer may conduct acceptance tests. The Engineer will directly base acceptance on the acceptance test results, the asphalt cement quality, the Contractor's QC Plan work, and the comparisons of the acceptance test results to the QC test results. The Engineer may elect to utilize test results of the Contractor in some situations toward judging acceptance. All acceptance tests shall be performed by qualified technicians at qualified laboratories following AASHTO or DeDOT procedures, and shall be evaluated using Quality Level Analysis.

The Contractor shall supply, capture, and mark samples, as directed, from delivery trucks before the trucks leave the production plant. The sample shall represent the material produced by the Contractor,

and shall be of sufficient size to allow the Contractor to complete all required acceptance tests. The captured sample shall be from the Contractors specified delivery truck.

The first sample of the production day will be randomly generated by the Contractor between loads 0 and 12 (0-250 tons). Subsequent samples will be randomly generated by the Contractor on 500-ton sub-lots for the production day. Unacceptable samples may be a basis for rejection of material if the QC plan is not followed as approved for sample retrieval. Either splitting a large sample or getting multiple samples that equally represent the material is acceptable. The Contractor will perform all splitting and handling of samples after they are obtained.

The Engineer will evaluate and accept the material on a lot basis, based on testing performed by the Contractor. All the material within a lot shall have the same JMF (mixture ID). The lot size shall be targeted for 2000 tons or a maximum period of three days, whichever is reached first. If the 2000<sup>th</sup> ton target lot size is achieved during a production day, the lot size shall extend to the end of that production day. The Contractor may interrupt the production of one JMF in order to produce different material; this type of interruption will not alter the determination of the size or limits of material represented by a lot. The Contractor will evaluate each lot on a subplot basis and reported to the Engineer. The size for each subplot shall be 100 to 500 tons and testing for the sub lots will be completed on a daily basis. For each subplot, the Engineer will evaluate one sample.

The target size of sub-lots within each lot, except for the first sample of the production day, is equal-sized 500 ton sub lots and will be based upon anticipated production, however, more or fewer sublots, with differing sizes, may result due to the production schedule and conditions. If the actual production is less than anticipated, and it's determined a sample will not be obtained (based upon the anticipated tonnage), a new sample location will be determined on a statistically random, unbiased basis based upon the new actual production. If the actual production is going to be 50 tons or greater over the anticipated sub lot production, a new sample location will be determined on a statistically random, unbiased basis based upon the new actual production. The Contractor will combine the evaluation and test results for all of the applicable sublots in order to evaluate each individual lot and report results to the Engineer

The Contractor will conduct the following tests in order to characterize the material for the pavement compaction quality, and to judge acceptance and the pay adjustment for the material:

- AASHTO T312 - Preparing a mixture samples using a gyratory compactor.
- AASHTO T166, Method C (Rapid Method) - Bulk specific gravity of compacted samples.
- AASHTO T308 - Asphalt cement content.
- AASHTO T30 - Aggregate gradations, using samples from the asphalt cement content test.
- AASHTO T209 - Theoretical maximum specific gravity.
- ASTM Provisional Test Method - Rapid Drying of Compacted and Loose Bituminous Asphalt Specimens using Vacuum Drying Method

**(b) Pavement Construction - Tests and Evaluations.**

The Engineer will directly base acceptance on the compaction acceptance test results, and on the inspection of the construction, the Contractor's QC Plan work, lift thickness as referenced in the contract documents, joint quality as referenced in the contract documents, surface texture as referenced in the

contract documents, and possibly the comparisons of the acceptance test results to the independent test results. For the compaction acceptance testing, the Contractor will sample the work on a statistically random basis, and will test and evaluate the work using lots.

Prior to paving a road segment, the Contractor shall notify the Engineer of any locations within that road segment that may not be suitable to achieve minimum (93%) compaction due to existing conditions. The Contractor shall schedule and hold a meeting in the field with the Engineer in order to discuss all areas that may potentially be applicable to Table 5a before paving starts. Areas that will be considered for Table 5a will be investigated in accordance to the method described in Appendix B. If this meeting is not held prior to paving, no areas will be considered for Table 5a. Areas of allowable exemptions that will not be cored include the following: partial-depth patch areas, driveway entrances, paving locations of less than 100 tons, areas around manholes and driveway entrances, and areas of paving that are under 400 feet in continuous total length and/or 5 feet in width.

The exempt areas around manholes will be a maximum of 4 feet transversely on either side from the center of the manhole, and 20 feet longitudinally on either side from the center of the manhole. The exempt areas around driveway entrances shall be the entire width of the driveway, and 3 feet from the edge of the longitudinal joint next to the driveway. Areas of exemption that will be cored for informational purposes only shall include: areas where the mat thickness is less than three times the nominal maximum aggregate size as directed by the Engineer, violations of Section 401.08 in the Standard Specifications as directed by the Engineer, and areas shown to contain questionable subgrade properties as proven by substantial yielding under a fully legally loaded truck. Failure to obtain core samples in these areas will result in zero payment for compaction regardless of the exempt status.

The Engineer will evaluate and accept the compaction work on a daily basis based on contractors provided information. Payment for the compaction will be calculated by using the material production lots as referenced in **.05 Acceptance Plan (a) Material Production - Tests and Evaluation** and analyzing the compaction results over the individual days covered in the material production lot. The compaction results will be combined with the material results to obtain a payment for this item.

The minimum size of a compaction lot shall be 100 tons. If the compaction lot is between 101 and 1000 tons, the Contractor shall randomly determine four compaction acceptance test locations. If the compaction lot is between 1001 and 1500 tons, the Contractor shall randomly determine six compaction acceptance test locations. If the compaction lot is between 1501 and 2000 tons, the Contractor shall randomly determine eight compaction acceptance test locations. If the compaction lot is greater than 2000 tons, the Contractor shall randomly determine two compaction acceptance test locations per 500 tons.

If a randomly selected area falls within an approved exemption area, the Contractor will select one more randomly generated location to be tested per the requirements of this Specification. If that cannot be accomplished, or if an entire location has been declared exempt, the compaction testing shall be performed as per these Specifications but a note will be added to the results that the location was an Engineer approved exempt location.

Testing locations will be a minimum of 1.5 feet from the newly placed longitudinal joint and 50 feet from a new transverse joint. If the Contractor chooses to cut companion cores for the Engineer, they shall be located within one foot of the Contractors cores along the longitudinal direction and in-line with the Contractors cores in the longitudinal plane.

Exactly at the locations marked by the Contractor, the Contractor shall cut a core, 6 inches in diameter, through the full lift depth.

The Contractor shall notify the Engineer prior to starting paving operations with approximations of the tonnage to be placed.

The Contractor shall provide any traffic control required for the structural number investigation, sampling, and testing work at no additional cost to the City.

The Contractor shall cut each core with care in order to prevent damaging the core. The pavement shall have a maximum temperature of 140EF when cores are cut from it. Immediately upon removal of a core from the roadway, the Contractor shall adequately label it. The Contractor shall protect the core by supplying a 6-inch plastic concrete cylinder mold, or an approved substitute, and placing the core in it. If more than one core is in the same mold, the Contractor shall place paper between them. The Contractor shall attach a completed QC test record for the representative area to the corresponding core.

The Contractor shall repair the core hole per Appendix A, Repairing Core Holes in Hot-Mix Asphalt Pavements. Core holes shall be filled immediately. Failure to repair core holes at the time of coring will result in zero pay for compaction testing for the area in question.

The Contractor will conduct the following tests on the applicable portion of the cores in order to evaluate their quality:

- AASHTO T166, Method C (Rapid Method) - to determine the bulk specific gravity of the cores.
- AASHTO T209 - to calculate the theoretical maximum specific gravity and the density of the non-compacted mixtures.
- ASTM Provisional Test Method - Rapid Drying of Compacted and Loose Bituminous Asphalt Specimens using Vacuum Drying Method.

The Contractor will use the average of the last five test values of the same JMF (mixture ID) material at the production plant in order to calculate the average theoretical maximum specific gravity of the cores. The average will be based on the production days test results and as many test results needed from previous days production to have an average of five samples. If there are less than five values available, the Contractor will use the JMF design value in addition to the available values to calculate the average theoretical maximum specific gravity.

#### **.06 Payment and Pay Adjustment Factors.**

The Contractor shall include the costs for all materials, labor, equipment, tools, and incidentals necessary to meet the requirements of this specification in the bid price per ton for the hot-mix asphalt. Payment to the Contractor for the hot-mix asphalt item(s) will be based on the Contract price per ton and the pay adjustments described in this specification. The Contractor will determine pay adjustments for the hot-mix asphalt item(s) based on the Acceptance Plan and report information to the Engineer for evaluation. The Contractor will determine both a pay adjustment for the material and a pay adjustment for the pavement construction again reporting to the Engineer. Note that the material portion of the total pay adjustment is 70 percent and the pavement construction portion is 30 percent. For replaced material or work, the Contractor will not apply the Pay Adjustment applicable to the material or work replaced; a new Pay Adjustment will be calculated based on the qualities of the new material. Even if one portion of the pay adjustment (material or construction) is not applied, the Contractor may apply the pay adjustment to the other portion. All adjustments (**penalty, bonus has been eliminated**) shall be paid under this item

number in the contract.

**(a) Material Production - Pay Adjustment.**

The Contractor will determine the material pay adjustment by evaluating the production material based on the following parameters:

- Gradation of the 2.36 mm (#8) sieve.
- Gradation of the 0.075 mm (#200) sieve.
- Asphalt cement content.
- Air void content

Using the JMF target value, the single test tolerance (from Table 3), and the test values, the Engineer will use the following steps to determine the material pay adjustment factor for each lot of material:

1. For each parameter, calculate the mean value and the standard deviation of the test values for the lot to the nearest 0.1 unit.
2. For each parameter, calculate the Upper Quality Index (QU):  
 $QU = ((JMF \text{ target}) + (\text{single test tolerance}) - (\text{mean value})) / (\text{standard deviation}).$
3. For each parameter, calculate the Lower Quality Index (QL):  
 $QL = ((\text{mean value}) - (JMF \text{ target}) + (\text{single test tolerance})) / (\text{standard deviation}).$
4. For each parameter, locate the values for the Upper Payment Limit (PU) and the Lower Payment Limit (PL) from Table 2 - Quality Level Analysis by the Standard Deviation Method. (Use the column for An@ representing the number of sublots in the lot. Use the closest value on the table when the exact value is not listed).
5. Calculate the PWL for each parameter from the values located in the previous step:  
 $PWL = PU + PL - 100.$
6. Calculate each parameter's contribution to the payment adjustment by multiplying its PWL by the weight factor shown in Table 3 for that parameter.
7. Add the calculated adjustments of all the parameters together to determine the Composite PWL for the lot.
8. From Table 4, locate the value of the Pay Adjustment Factor corresponding to the calculated PWL.
9. For each lot, determine the final material price adjustment:

Final Pay Adjustment =

(Lot Quantity) x (Item Bid Price) x (Pay Adjustment Factor) x 70%. This final pay calculation will be paid to the tenth of a percent.

In lieu of being assessed a pay adjustment penalty, the Contractor may choose to remove and replace the material at no additional cost to the City. If the PWL of any single material characteristic is below 60, the Engineer may require the removal and replacement of the material at no additional cost to the City.

The test results from the Contractor on production that is less than 100 tons will be combined with the two most recently completed Contractor tests with the same Mixture ID to calculate payment for

the lot encompassing the single test. If that cannot be accomplished, the approved JMF will be used to calculate payment for the lot encompassing the single test. Payment for previously closed lots will not be affected by the analysis.

When a sample is out of the acceptable tolerance for any Materials pay criteria, that sample will be isolated. For payment purposes, the test result of the out of acceptable tolerance sample will be combined with the two previous acceptable samples of the same JMF and analyzed per this specification. The material that is considered out of the acceptable tolerance will only include the material within the represented sub-lot (i.e., a maximum of 500 tons). If the previous acceptable test result is from the previous production day, only the material produced on the second production day will be considered out of tolerance. All future sub lots will not include the isolated test.

If, during production, a QA sample test result does not meet the acceptable tolerances and the Contractors QC sample duplicates the QA sample test result, the Contractor can make an appropriate change to the mixture (within the JMF boundaries), and request to have that sample further isolated. If this request is approved, and the Contractor has made a change, the third load after the change will be tested. If that sample test result shows compliance with the specifications, the material that is considered out of the acceptable tolerance will include the material from the previous acceptable test result to the third load after the initially sampled and tested sample. If the sample does not meet the specification requirements, the Engineer will no longer accept material. Production may resume when changes have been made and an acceptable sample and test result is obtained.

<b>Table 2 - Quality Level Analysis by the Standard Deviation Method</b>							
<b>PU or PL</b>	<b>QU and QL for An@ Samples</b>						
	<b>n = 3</b>	<b>n = 4</b>	<b>n = 5</b>	<b>n = 6</b>	<b>n = 7</b>	<b>n = 8</b>	<b>n = 9</b>
100	1.16	1.50	1.79	2.03	2.23	2.39	2.53
99		1.47	1.67	1.80	1.89	1.95	2.00
98	1.15	1.44	1.60	1.70	1.76	1.81	1.84
97		1.41	1.54	1.62	1.67	1.70	1.72
96	1.14	1.38	1.49	1.55	1.59	1.61	1.63
95		1.35	1.44	1.49	1.52	1.54	1.55
94	1.13	1.32	1.39	1.43	1.46	1.47	1.48
93		1.29	1.35	1.38	1.40	1.41	1.42
92	1.12	1.26	1.31	1.33	1.35	1.36	1.36
91	1.11	1.23	1.27	1.29	1.30	1.30	1.31
90	1.10	1.20	1.23	1.24	1.25	1.25	1.26
89	1.09	1.17	1.19	1.20	1.20	1.21	1.21
88	1.07	1.14	1.15	1.16	1.16	1.16	1.17

**Table 2 - Quality Level Analysis by the Standard Deviation Method**

PU or PL	QU and QL for An@ Samples						
	n = 3	n = 4	n = 5	n = 6	n = 7	n = 8	n = 9
87	1.06	1.11	1.12	1.12	1.12	1.12	1.12
86	1.04	1.08	1.08	1.08	1.08	1.08	1.08
85	1.03	1.05	1.05	1.04	1.04	1.04	1.04
84	1.01	1.02	1.01	1.01	1.00	1.00	1.00
83	1.00	0.99	0.98	0.97	0.97	0.96	0.96
82	0.97	0.96	0.95	0.94	0.93	0.93	0.93
81	0.96	0.93	0.91	0.90	0.90	0.89	0.89
80	0.93	0.90	0.88	0.87	0.86	0.86	0.86
79	0.91	0.87	0.85	0.84	0.83	0.82	0.82
78	0.89	0.84	0.82	0.80	0.80	0.79	0.79
77	0.87	0.81	0.78	0.77	0.76	0.76	0.76
76	0.84	0.78	0.75	0.74	0.73	0.73	0.72
75	0.82	0.75	0.72	0.71	0.70	0.70	0.69
74	0.79	0.72	0.69	0.68	0.67	0.66	0.66
73	0.75	0.69	0.66	0.65	0.64	0.63	0.63
72	0.74	0.66	0.63	0.62	0.61	0.60	0.60
71	0.71	0.63	0.60	0.59	0.58	0.57	0.57
70	0.68	0.60	0.57	0.56	0.55	0.55	0.54
69	0.65	0.57	0.54	0.53	0.52	0.52	0.51
68	0.62	0.54	0.51	0.50	0.49	0.49	0.48
67	0.59	0.51	0.47	0.47	0.46	0.46	0.46
66	0.56	0.48	0.45	0.44	0.44	0.43	0.43
65	0.52	0.45	0.43	0.41	0.41	0.40	0.40
64	0.49	0.42	0.40	0.39	0.38	0.38	0.37
63	0.46	0.39	0.37	0.36	0.35	0.35	0.35
62	0.43	0.36	0.34	0.33	0.32	0.32	0.32
61	0.39	0.33	0.31	0.30	0.30	0.29	0.29

Table 2 - Quality Level Analysis by the Standard Deviation Method							
PU or PL	QU and QL for An@ Samples						
	n = 3	n = 4	n = 5	n = 6	n = 7	n = 8	n = 9
60	0.36	0.30	0.28	0.27	0.27	0.27	0.26
59	0.32	0.27	0.25	0.25	0.24	0.24	0.24

Table 3 - Material Parameter Weight Factors		
Material Parameter	Single Test Tolerance (+/-)	Weight Factor
Asphalt Content	0.4	0.30
#8 Sieve (19 mm or >)	7.0	0.30
#8 Sieve (12.5 mm or <)	5.0	0.30
#200 Sieve (0.075 mm) Sieve	2.0	0.30
Air Voids (4.0% Target)	1.5	0.10

Table 4 - PWL Pay Adjustment Factors	
PWL	Pay Adjustment Factor (%)
100	0
99	0
98	0
97	0
96	0
95	0
94	0
93	0
92	(-1)
91	(-2)
PWL (when <91)	(PWL - 100)



**(b) Pavement Construction - Pay Adjustments.**

The Contractor will determine the pavement construction pay adjustment, and report to the Engineer, by evaluating the construction of the pavement, based on the following parameter:

- Degree of compaction of the in-place material

Using the test values for the cores, the Contractor will use the following steps to determine the pavement construction pay adjustment for each lot of work. Note that the material portion of the total pay adjustment is 70 percent and the pavement construction portion is 30 percent.

1. Calculate the average density values from the subplot tests values, to the nearest 0.1 unit.
2. Calculate the Degree of Compaction:  
Degree of Compaction =  
 $((\text{Core Bulk Specific Gravity}) / (\text{Theoretical Maximum Specific Gravity})) \times 100\%$ .
3. The average compaction for the sublots shall be averaged together for the compaction level of the lot. The lots compaction test level shall be averaged to the whole percent.
4. Locate the value of the Payment Adjustment Factor corresponding to the calculated degree of compaction from Table 5 or Table 5a.
5. Determine the pavement construction price adjustment by using the following formula:  
Pay adjustment = (Lot Quantity) x (Bid Price) x (Pay Adjustment Factor) x 30%.

<b>Table 5: Compaction Price Adjustment Highway Locations</b>	
<b>Degree of Compaction (%)</b>	<b>Pay Adjustment Factor (%)</b>
>97	-100*
96	0
95	0
94	0
93	0
92	0
91	-10
90	-25
89	-30
≤88	-100*

\* or remove and replace it at Engineer's discretion

<b>Table 5a: Compaction Price Adjustment Other<sup>1</sup> Locations</b>	
<b>Degree of Compaction (%)</b>	<b>Pay Adjustment Factor (%)</b>
>96	-100*
95	
94	0
93	0
92	0
91	0
90	0
89	0
88	-3
87	-15
86	-25
85	-30
84	-100*

\* or remove and replace at Engineer's discretion

<sup>1</sup> This chart is to be used for areas where the structural value of the area to be paved is less than 1.75 as determined by the Engineer. See Appendix B - Method for Obtaining Cores for Determination of Roadway Structure. This chart is applicable to rehabilitation work only; full depth construction will not be considered for Table 5a.

#### **.07 Dispute Resolution.**

Disputes or questions about any test result shall be immediately brought to the attention of the Contractor and the Engineer. When there is a significant alleged discrepancy regarding the Engineer's acceptance test results, the Contractor must claim a dispute within two operational days of the test date. The following dispute resolution procedures will be used.

The Engineer and the Contractor will review the sample quality, the test method, the laboratory equipment, and the laboratory technician. If these factors are not the cause of the dispute, a third party dispute resolution will be used.

For third party resolution testing, it can be either at another Contractor's laboratory, or an independent accredited laboratory.

When disputes over production testing occur, the samples used for Dispute Resolution testing will be those samples the Contractor properly captured, labeled, and stored, as described in the second paragraph of the section of these specifications titled **.05 Acceptance Plan, (a) Material Production - Tests and Evaluations**. If no samples are available, the original testing results will be used for payment calculations.

Dispute Resolution samples for air void content will be heated by a microwave oven.

If there is a discrepancy between the Engineer's acceptance test result and the Contractor's test result, the Contractor may ask for the Dispute Resolution sample to be tested. If the Dispute Resolution sample substantiates the original acceptance test result, the Contractor, after two such Dispute Resolution samples, will be charged a fee of \$125 for all further Dispute Resolution cores that substantiate the acceptance test result. If the Dispute Resolution sample substantiates the Contractor's test result, the Contractor will not be charged a fee.

When disputes over compaction core test results occur, the Engineer's acceptance core will be used for the dispute resolution sample. The Contractor will be advised on when the testing will occur as referenced above to witness the testing.

The results of the dispute resolution testing shall replace all of the applicable disputed test results for payment purposes.

2/1/2012

City

## **Appendix A - Repairing Core Holes in Hot-Mix Asphalt Pavement**

### **Description.**

This appendix describes the procedure required to acceptably repair core holes in a bituminous concrete pavement.

### **Materials and Equipment.**

The following material shall be available to complete this work:

- Patch Material - A DeIDOT approved High Performance Cold Patch material shall be used.

The following equipment shall be available to complete this work:

- Sponge or other absorbent material - Used to extract water from the hole.
- Compaction Hammer - Shall be mechanical, with a flat, circular tamping face smaller than 6 inches in diameter. The tamping head shall be connected to an electrical, pneumatic, or gasoline driven tamping device.

### **Construction Method.**

After core removal from the hole, remove all excess water from within the hole, and prevent water from re-entering the hole.

Place the patch material in lifts no greater than 3 inches. If the hole is deeper than 3 inches, use two lifts of approximately equal depths so that optimum compaction is achieved. Make sure that the patch surface matches the grade of the existing roadway. Make every effort to achieve the greatest possible compaction

### **Performance Requirements.**

The Engineer will judge the patch on the following basis:

- The patch shall be well compacted
- The patch surface shall match the grade of the surrounding roadway surface.

### **Basis of Payment.**

No measurement or payment will be made for the patching work. The Contractor must gain the Engineer's acceptance of the patching work before the Engineer will accept the material represented by the core.

## **Appendix B - Method for Obtaining Cores for Determination of Roadway Structure**

The Contractor is responsible for obtaining cores in areas that they propose are eligible for compaction price adjustments according to Table 5a in this specification. Table 5a is not applicable for new full-depth pavement box construction. Cores submitted for this process shall be obtained according to the following process.

1. Contact City personnel to determine if information about the area is already available. If the City has already obtained cores in the location that is being investigated, the contractor may opt to use the laboratory information for the investigation and not core the area on their own.
2. If the City does not have information concerning the section of the roadway, the contractor needs to contact the City to arrange for verification of coring operations. Arrangements shall be made to allow for an individual from the City to be on the site when the cores are obtained. Cores will be turned over to the City for evaluation.
3. The contractor is responsible for providing all traffic control and repairing core holes in accordance to 401699 Appendix A - Repairing Core Holes in Hot-Mix Asphalt Pavements.
4. Cores are to be taken throughout the entire project for the area in question. Cores will be spaced, from the start of the project in increments determined based on field and project specifics. Cores will be evenly distributed throughout the project location. The cores will be taken in the center of the lane in question.
5. Additional cores may be taken at other locations, if surface conditions indicate that there may be a substantial difference in the underlying section. The location of these cores should be documented and submitted to City.
6. Cores shall be full depth and include underlying materials. If there is a stone base included in the pavement section, at a minimum 1 core must have information concerning the thickness of the base. This is determined by augering to the subgrade surface.
7. The calculations used to determine the structural capacity of the roadway is as follows. If the contractor finds, upon starting the coring process, that the areas are of greater thickness than applicable to Table 5a, they may terminate the coring process on their own and retract the request.

### **Structural Number Calculations**

Each pavement box material is assigned a structural coefficient based upon AASHTO design guides. The structural coefficient is used to determine the total strength of the pavement section.

Materials used in older pavement sections are assigned lower structural coefficients to compensate for aging of the materials. The coefficients used to determine the structural number of an existing pavement are:

<b>Existing Material</b>	<b>Structural Coefficient</b>
HMA	0.32
Asphalt Treated Base	0.26

Existing Material	Structural Coefficient
Soil Cement	0.16
Surface Treatment (Tar & Chip)	0.10
GABC	0.14
Concrete	0 - 0.7*

- \* The Structural Coefficient of Concrete is dependent upon the condition of the concrete. Compressive strengths & ASR analysis are used to determine condition - contact the Engineer if this situation arises.

Newly placed materials use a different set of structural coefficients. They are as follows:

New Material	Structural Coefficient
HMA	0.40
Asphalt Treated Base (BCBC)	0.32
Soil Cement	0.20
GABC	0.14

**Example:**

Location includes placement of a 1.25@ Type C overlay on 2.25@ Type B. Existing roadway is cored and is shown to consist of 2@ HMA on 7@ GABC.

Calculation:

For the Type B lift the calculation would be:

Existing HMA	2 * 0.32	=	0.64
GABC	7 * 0.14	=	<u>0.98</u>
			1.62

For the Type C lift the calculation would be:

Newly Placed B	2.25 * 0.4	=	0.90
Existing HMA	2 * 0.32	=	0.64
GABC	7 * 0.14	=	<u>0.98</u>
			2.52

## **710507 – ADJUST AND REPAIR EXISTING SANITARY CLEANOUTS**

### **Description:**

This work consists of adjusting and repairing the existing sanitary cleanout in accordance with notes and details shown on the Plans and/or as directed by the Engineer.

### **Materials and Construction Methods:**

Portland cement concrete for the item shall be Class A, and shall conform to the requirements of Section 1022 of the Standard Specifications.

The sanitary cleanout shall be raised and adjusted in accordance with the details shown on the Plans, and curing of the P.C. concrete shall be done in accordance with the applicable requirements of Section 501 of the Standard Specifications.

### **Method of Measurement:**

The quantity of sanitary cleanouts adjusted will be measured as the actual number of each adjusted and accepted.

### **Basis of Payment:**

The quantity of sanitary cleanouts adjusted will be paid for at the Contract unit price per each. Price and payment shall constitute full compensation for furnishing all materials including concrete, excavation and backfill, disposal of discarded materials, adjusting the sanitary cleanout, for all labor, equipment, and incidentals necessary to complete the item.

## **710600 - ADJUSTING EXISTING MONUMENT BOX AND/OR LAMP HOLE**

### **Description:**

This work consists of adjusting the existing monument box/lamp hole in accordance with notes and details shown on the Plans and/or as directed by the Engineer.

### **Materials and Construction Methods:**

Portland cement concrete for the item shall be Class A, and shall conform to the requirements of Section 1022 of the Standard Specifications.

The monument box/lamp hole shall be raised and adjusted in accordance with the details shown on the Plans, and curing of the P.C. concrete shall be done in accordance with the applicable requirements of Section 501 of the Standard Specifications.

### **Method of Measurement:**

The quantity of monument boxes/lamp holes adjusted will be measured as the actual number of each adjusted and accepted.

### **Basis of Payment:**

The quantity of monument boxes/lamp holes adjusted will be paid for at the Contract unit price per each. Price and payment shall constitute full compensation for furnishing all materials including concrete, excavation and backfill, disposal of discarded materials, adjusting the monument box, for all labor, equipment, and incidentals necessary to complete the item.

### **NOTE:**

Extreme care must be taken by the contractor to insure that the center stones or concrete monuments are not disturbed while adjusting monument boxes. If a center stone or concrete monument is disturbed during construction and installation of a monument box, a registered land surveyor will be required to reset the disturbed center stones or concrete monument at the contractor's expense.



**763531 – WORK ORDER MOBILIZATION AND DE-MOBILIZATION**

**DESCRIPTION:**

This work consists of mobilization and de-mobilization for work orders.

**CONSTRUCTION METHODS:**

- A. Perform all operations necessary for the assembling and setting up of the work order, including the initial movement of personnel and equipment to the work order site, the establishment of the offices, shops, plants, storage areas, and sanitary facilities, any other activities required by the contract and by law or regulation, and all other work and operations that must be performed prior to beginning compensable items of work on the work order.
- B. Perform all operations necessary for the final cleanup of the work order jobsite, for de-mobilization of all personnel and equipment, and for all paperwork necessary to close out the work order.

**METHOD OF MEASUREMENT:**

This Department will not measure this item.

**BASIS OF PAYMENT:**

The Department will pay for work order mobilization and de-mobilization at the contract unit price per each. Price and payment constitutes full compensation for all work associated with mobilizing and demobilizing the work order as described above and for providing all materials, labor, equipment and incidentals required to complete the work.

12/7/2021

## **801500 - MAINTENANCE OF TRAFFIC – ALL INCLUSIVE**

### **Description:**

This item shall consist of furnishing, installing, maintaining and/or relocating the necessary temporary traffic control devices used to maintain vehicular, bicycle and pedestrian traffic, including persons with disabilities in accordance with the Americans with Disabilities Act, as amended. All work shall be performed in a manner that will provide reasonably safe passage with the least practicable obstruction to all users, including vehicular, bicycle and pedestrian traffic.

All requirements of the Delaware Manual on Uniform Traffic Control Devices (MUTCD), Part 6, herein referred to as the Delaware MUTCD. (Latest edition with all revisions made up to the date of Advertisement of this project) shall apply for all temporary traffic control devices. Any, and all, control, direction, management and maintenance of traffic shall be performed in accordance with the requirements of the Delaware MUTCD, notes on the Plans, this specification, and as directed by the Engineer.

The Contractor shall be aware that the Case Diagrams and safety measures outlined in the Delaware MUTCD are for common construction situations and modifications may be warranted based on the complexity of the job. The Contractor shall submit justification for modifications to the Temporary Traffic Control Plan (TTCP) to the Engineer for approval prior to implementation.

The City reserves the right to impose additional restrictions, as needed, for the operational movement and safety of the traveling public. The City reserves the right to suspend the Contractor's operations until compliance with the Engineer's directive for remedial action, based on but not limited to the following reasons:

1. The Contractor's operations are not in compliance with the Delaware MUTCD, the specifications or the Plans.
2. The Contractor's operations have been deemed unsafe by the Engineer or City.

### **Materials and Construction Methods:**

The Contractor shall submit a Temporary Traffic Control Plan (TTCP) or a Letter of Intent to use the Plan recommended Delaware MUTCD Case Diagram(s) at or prior to the pre-construction meeting. The Contractor shall submit the TTCP for all Contractor and subcontractor work to be performed on the project for the City's approval before the start of work.

The Contractor shall be required to have an American Traffic Safety Services Association (ATSSA) certified Traffic Control Supervisor on the project. The authorized designee must be assigned adequate authority, by the Contractor, to ensure compliance with the requirements of the Delaware MUTCD and provide remedial action when deemed necessary by the Engineer. The ATSSA certified Traffic Control Supervisor's sole responsibility shall be the maintenance of traffic throughout the project. This responsibility shall include, but is not limited to, the installation, operations, maintenance and service of temporary traffic control devices. Also required is the daily maintenance of a log to record maintenance of traffic activities, i.e., number and location of temporary traffic control devices; and times of installation, changes and repairs to temporary traffic control devices. The ATSSA Traffic Control Supervisor shall serve as the liaison with the Engineer concerning the Contractor's maintenance of traffic. The name, contact number and certification for the designated Traffic Control Supervisor shall be submitted at or prior to the pre-construction meeting. The cost of the ATSSA certified Traffic Control Supervisor shall be incidental to this item.

Temporary traffic control devices shall be maintained in good condition in accordance with the brochure entitled "Quality Guidelines for Temporary Traffic Control Devices", published by the American

Traffic Safety Services Association (ATSSA). Any temporary traffic control devices that do not meet the quality guidelines shall be removed and replaced with acceptable devices. Failure to comply will result in work stoppage with time charges continuing to be assessed.

Any existing signs that conflict with any temporary or permanent construction signs shall be covered as needed or as directed by the Engineer. The cost for temporarily covering conflicting signs shall be incidental to this item.

Access to all transit stops located within the project limits shall be maintained unless otherwise directed by the Plans or the Engineer. Maintaining access shall include maintaining an area for the transit vehicle and also an accessible path for pedestrians to safely access the transit stop.

The Contractor shall notify the Engineer, in writing, no less than four (4) calendar days prior to the start of any detour(s) and road closures. The Engineer will notify the following entities via the contractors two week schedule:

- City Fire Department
- City Managers
- City Police
- Delaware Transit Corporation (DTC)

The contractor shall provide detour routes to be used in writhing. This information shall be included on the two week schedule for each location where a detour is necessary. Detours shall only be permitted during normal working hours.

The Contractor shall notify the local 911 center if access to a fire hydrant is temporarily restricted. The Contractor shall provide written confirmation to the Engineer that the local 911 center has been notified.

If a detour is required during any part of this Contract, an approved detour plan shall be obtained from the City. All signs, barricades and other temporary traffic control devices required as part of the approved detour plan shall be installed and maintained by the Contractor on the route that is closed and on the detour route. Road closures without an approved detour plan shall not be allowed. If a road is closed without an approved detour plan, the Contractor's operations shall be stopped immediately.

The Contractor shall provide and maintain ingress and egress for each property abutting the construction area and each property located between the diversion points of any detour and the actual construction site. Construction activities which may temporarily or otherwise interfere with property access shall be coordinated in advance with the affected property owners.

The Contractor shall conduct construction operations in a manner which will minimize delays to traffic, and shall meet the following requirements:

1. If work is being performed within 200 feet in any direction of an intersection that is controlled by a traffic signal, the flagger(s) shall direct the flow of traffic in concert with the traffic signals in construction areas to avoid queuing, unless active work prohibits such action. The flagger shall direct traffic to prevent traffic from queuing through an intersection (i.e., blocking an intersection). Only a Traffic Officer may direct traffic against the operation of a traffic signal and only until the operation occurring within the intersection is completed.

2. When a lane adjacent to an open lane is closed to travel, the temporary traffic control devices shall be set 2 feet (0.61 m) into the closed lane from the edge of the open lane, unless an uncured patch exists or actual work is being performed closer to the open lane with minimum restriction to traffic.
3. Lanes shall not be closed unless construction activity requiring lane closure is taking place, or will take place within the next hour. Lanes shall be reopened immediately upon completion of the work and at the end of each work day. Moving operations will require the lane closures be shortened as the work progresses and as traffic conditions warrant to minimize the length of the closure. The Contractor shall conduct construction operations in a manner so as to minimize disruption to traffic during peak hours and periods of heavy flow. The City reserves the right to stop or change the Contractor's operations, if in the opinion of the Engineer, such operations are unnecessary at that time or the operations are unnecessarily impeding traffic.
4. Work in the vicinity of traffic signals, shall be scheduled to minimize the time during which the signal is operated without detectors, and prior approval from the Engineer shall be required. TMC shall be notified in advance of cutting a loop detector, and be immediately notified once the loop detector has been reinstalled. The Contractor shall provide sufficient advance notice of the loop detector work with the Engineer to ensure the aforementioned requirements are met.

It is required that all temporary traffic control work and related items shall either be performed entirely by the Contractor's own organization, or totally subcontracted. Maintenance of equipment shall not be subject to this requirement.

Any deficiencies related to temporary traffic control that are reported to the Contractor shall be corrected immediately. Failure to comply will result in non-payment for those devices including flaggers that are found to be deficient for the duration of the deficiency. Deficiencies that are not corrected immediately shall result in suspension of work until items identified are brought back into compliance.

At the end of each day's work, the Contractor shall correct all pavement edge drop-offs in accordance with Table 6G-1 in the Delaware MUTCD. This corrective work shall be accomplished with Temporary Roadway Material (TRM) unless an alternate method is specified in the Plans. All ruts and potholes shall be filled with TRM as soon as possible but no later than the end of each work day. Placement and Payment of TRM shall be completed in accordance with Section 402 of the Standard Specifications. If temporary elimination of a drop-off hazard cannot be accomplished, then the area should be properly marked and protected with temporary traffic control devices such as temporary barricades, warning signs, flashing lights, etc. as required by Section 6G.21 of the Delaware MUTCD.

All open trench excavation accessible by vehicular traffic must be backfilled prior to the end of each working day. Steel plates shall not be used except in emergency situations and only with prior written approval from the Engineer unless otherwise directed by the Plans.

The Contractor shall submit, at or prior to the preconstruction meeting, detailed drawings including but not limited to existing striping lengths, lane and shoulder widths, turn lane lengths, locations of stop bars, turn arrows, crosswalks and railroad crossings. The drawings shall depict the existing pavement markings for each project location. These drawings will be reviewed by the City's Engineer to determine

the need for modification(s) for compliance with the Delaware MUTCD. Temporary pavement markings, on the final pavement surface, shall match the Plan dimensions and layout or the approved drawings of the permanent markings in compliance with Section 3 of the Delaware MUTCD. All conflicting or errant striping shall be removed as directed by the Engineer in compliance with the specifications for Item 748530 (Removal of Pavement Striping).

At the end of each day's operation and before traffic is returned to unrestricted roadway use, temporary striping shall be utilized when the existing pavement is milled and hot mix will not be placed the same day or more than a single course of hot mix is to be placed or permanent roadway striping cannot be placed on the same day as the placement of the final course of hot mix. Placement of temporary striping shall receive prior approval from the Engineer and the contractor shall apply temporary pavement markings in accordance with the requirements of Section 748 of Delaware Standard specifications and the Delaware MUTCD. Payment for temporary pavement striping shall be made at the unit price bid for item 748 – Painting of White or Yellow 4 inch line. Payment for final striping will be included in the applicable striping item.

The Contractor shall have temporary striping/delineating materials (such as raised markers, tape, and other approved materials) available at the job site for verification by the City prior to starting the hot-mix paving operation on roads to be immediately opened to traffic. These materials shall be used by the Contractor for temporary markings if he/she fails to apply temporary marking paint, etc., as required by the Delaware MUTCD. No paving operations on roads to be immediately opened to traffic will be allowed unless such verification has been made for the availability of the materials at the job site.

**Certification:**

Temporary traffic control devices used on all highways open to the public in this State shall conform to the Delaware MUTCD. All devices shall be crashworthy in accordance with the National Cooperative Highway Research Program (NCHRP) Report 350, the memorandum issued August 28, 1998 by The USDOT Federal Highway Administration, and/or in accordance with the latest edition of the Manual for Assessing Safety Hardware (MASH), published by the American Association of State Highway and Transportation Officials (AASHTO).

The Contractor shall submit certification for temporary traffic control devices or vendors used specifically on this project at or prior to the pre-construction meeting.

Certification of compliance with NCHRP report 350 and/or MASH is required for the following categories of temporary traffic control devices:

**Category I** contains small and lightweight channelizing and delineating control devices which includes cones, tubular markers, flexible delineator post and drums, all without any accessories or attachments.

**Category II** includes temporary traffic control devices that are not expected to produce significant vehicular velocity changes to impacting vehicles. These devices which shall weigh 45 kg or less, include Type I, II and III barricades, portable sign supports with signs, and intrusion alarms. Also included are drums, cones, and vertical panels with accessories or attachments.

**Category III** includes temporary traffic control devices that are expected to cause significant vehicular velocity changes to impacting vehicles. These devices which weigh more than 45 kg include temporary barrier, temporary impact attenuators, and truck-mounted attenuators.

**Category IV** includes portable or trailer-mounted devices such as arrow panels, variable message signs, temporary traffic signals and temporary area lighting.

For Category I devices, the manufacturer or Contractor may self-certify that the devices meet the NCHRP-350 and/or MASH criteria. The Contractor shall supply the Federal Highway Administration's NCHRP-350 and/or MASH acceptance letter for each type of device that falls under Category II and III devices.

**Basis of Payment:**

Payment for Item 801500 – Maintenance of Traffic, All Inclusive shall be made on an each day basis. The number of working days contained on a work order shall be the maximum number of days paid for Maintenance of traffic, All Inclusive for a given work order. If work is completed in less time than allotted on the work order, then only the number of days the contractor is actively working on site will be counted and paid under this item. Price and payment constitutes full compensation for all maintenance of traffic activities accepted by the Engineer, which shall include the cost of furnishing and relocating permanent and temporary traffic control signs, traffic cones or drums, submission of temporary traffic control plan(s), submission of existing pavement marking drawings, submission of all required certifications, labor, equipment and incidentals necessary to complete the item.

**NOTE**

If the Contractor does not complete the Contract work order within the Contract work order completion time (including approved extension time), the Contractor shall be responsible for providing the necessary temporary traffic control devices that are required to complete any remaining work. The costs of such temporary traffic control shall be borne by the Contractor. No additional payment will be made to the Contractor to maintain traffic in accordance with the Delaware MUTCD, contract plans and specifications. Temporary traffic control items include, but not limited to, warning lights, warning signs, barricades, plastic drums, P.C.C. safety barrier, flaggers, traffic officers, arrow panels, message boards, and portable impact attenuators.

01/10/2019

817539 – THERMOPLASTIC LINE, 4"  
817540 - THERMOPLASTIC LINE - LONG, 4"  
817541 - THERMOPLASTIC LINE, 5"  
817542 - THERMOPLASTIC LINE - LONG, 5"  
817543 - THERMOPLASTIC LINE, 6"  
817544 - THERMOPLASTIC LINE - LONG, 6"  
817545 - THERMOPLASTIC LINE, 10"  
817546 - THERMOPLASTIC TRANSVERSE LINE, 8"  
817547 - THERMOPLASTIC TRANSVERSE LINE, 12"  
**817548 - THERMOPLASTIC TRANSVERSE LINE, 16"**  
817557- SYMBOL - THERMOPLASTIC  
817560 - STRAIGHT ARROW THERMOPLASTIC  
817561 - LEFT OR RIGHT THERMOPLASTIC ARROW  
817562 - COMBINATION ARROW THERMOPLASTIC  
817563 -YELLOW THERMOPLASTIC ON SPEED HUMPS, 4"

Section 748 shall apply except as modified below.

**Subsection 748.09 Application.**

Add the following at the end of this subsection:

- (d) Reflectivity for Alkyd Type Thermoplastic Material.

After satisfactory completion of all striping work and written notification from the Contractor, the Department test the striping to ensure it has the minimum reflectivity. The testing will be completed within 30 calendar days from notification. The Contractor shall accept lower average readings derived from late testing due to the Contractor's failure to notify te Engineer. The Contractor may request that tests be conducted on completed phases or portions of the work. Approval of such a request will be at the discretion of the Engineer. Testing will be done using a Delta LTL-X Retrometer. Five readings will be taken per line per mile. Projects less than 1 mile in length will have a minimum of five readings per line.

The required minimum initial reflectivity reading in millicandellas shall be:

White 300  
Yellow 200

For striping below these minimums and above 125 millicandellas payment will be reduced as described under Basis of Payment.

Striping with an average reflectivity below 125 millicandellas shall be removed and replaced at the sole expense of the Contractor.

- (e) Guarantee for Alkyd Type Thermoplastic Material.

Acceptance of this project will be contingent upon successful completion of a 180 day observation period under traffic beginning upon the satisfactory completion of all striping work required by the Contract.

During the 180 day observation period the thermoplastic Pavement Marking Material furnished and installed under this Contract shall be warranted against failure due to blistering, excessive cracking, bleeding, staining, discoloration, oil content of the pavement materials, smearing and spreading under heat, deterioration due to contact with grease deposits, oil, diesel fuel, or gasoline drippings, chipping, spalling, poor adhesion to the pavement materials, vehicular damage, and wear. Any markings that have not performed satisfactorily during the 180 day observation shall be replaced by the Contractor at no expense to the Department.

Marking replacement shall be performed in accordance with the requirements specified herein for the initial application, including but not limited to possible surface cleaning, pavement marking removal, seasonal and weather limitations, etc.

The Contractor shall replace or renew, entirely at his/her expense, the amount of pavement markings deemed by the Engineer to have failed to perform useful service during the period noted above. The replacement material installed under this guarantee shall be the same as the original material.

**Subsection 748.11 Basis of Payment.**

Delete the first paragraph and insert the following:

The quantity of permanent pavement marking (alkyd thermoplastic) 4", 5", 6", 8", 10", 12" or 16" line will be paid for at the Contract unit price per linear foot of line and the Contract unit price per square foot of symbol. All arrows shall be paid for as each unless payment is reduced due to below minimum reflectivity as described below:

For pavement markings with reflectivity readings of 125 millicandellas or above but below 300 millicandellas for white or 200 millicandellas for yellow payment will be pro-rated based on the following formula:

$$\frac{A \times B}{C}$$

- A = Average measured reflectivity readings\*
- B = Contract bid price for striping \*\*
- C = Required minimum initial reading

- \* = Must be greater than or equal to 125 millicandellas
- \*\* = Item bid price; not material cost

1/26/2018



**905004 – Inlet Sediment Control, Drainage Inlet**  
**905004-A – Reuse Inlet Sediment Control, Drainage Inlet**

**Description:**

This work consists of furnishing and installing Inlet Sediment Control (ISC) devices in all drainage inlets within the construction limits prior to the milling of the location and promptly removing once the final paving and cleanup has been completed.

**Materials and Construction Methods:**

All materials shall be in accordance with the applicable requirements of section 905 of the DelDOT Standard Specifications and as revised here or as directed by the engineer.

The ISC device shall be installed by first removing the frame of the inlet and placing the device in the inlet and then replacing the grate in order to secure the ISC device in place and to insure there is a tight seal as to prevent any/all debris from entering.

The ISC devices are to be reused on the next contract location unless they are too damaged or worn to do so as approved by the engineer. At which time, the contractor will be able to utilize a new device with the approval of the engineer.

**Method of Measurement:**

The quantity of Inlet Sediment Control, Drainage Inlet devices will be measured as the actual number of each installed and removed before and after the construction process.

The quantity of Reuse, Inlet Sediment Control, Drainage Inlet devices will be measured as the actual number of ISC devices reused on the next contract location.

**Basis of Payment:**

The quantity of Inlet Sediment Control, Drainage Inlet devices will be paid for at the Contract unit price per each. Price and payment shall constitute full compensation for furnishing all materials, installing and removing the ISC device, for all labor, equipment, and incidentals necessary to complete the item.

The quantity of Reuse, Inlet Sediment Control, Drainage Inlet devices will be paid for at the Contract unit price per each. Price and payment shall constitute full compensation for all materials, reusing the ISC device, for all labor, equipment, and incidentals necessary to complete the item.

**NOTE:**

Extreme care must be taken by the contractor to insure that no debris enters the drainage inlets before, during or after construction. Contractor shall be responsible for all debris that enters the basin during construction.

**999000 – PROTECTION OF TREES WITHIN STREET RIGHT OF WAY AND  
PROJECT LIMITS**

- A. A tree is defined as a woody perennial plant, typically having one dominant vertical trunk and a height greater than fifteen feet at maturity.
- B. Restore trees within the project boundaries and outside the limits of permanent work to a condition that matches or exceeds the conditions existing prior to the start of work. Contractor shall confine all activities to the general areas shown on the drawings.
- C. Comply with all local tree protection ordinances including, but not limited to Wilmington City Code, Chapter 46-Vegetation, Article II-Trees and Shrubs
- D. Do not deface, injure, or destroy trees or shrubs, nor remove or cut them without prior approval from the City.
- E. Except where trees are indicated to be removed, the Contractor shall exercise all necessary precautions as not to damage or destroy any trees, including those lying within street rights-of-way and project limits. Contractor shall protect roots, stems, branches, and trunk between the tree driplines, within Tree Protection Zones (TPZ), designated by the City (Appendix A, Figure 1).
  - a. Vehicular traffic, storage of materials and equipment, and soil disturbance is prohibited within pervious areas (i.e. grass, mulch, soil, pavers) within the TPZ. Vehicular traffic and storage of materials and equipment is permitted on concrete or asphalt surfaces within the dripline.
  - b. Root pruning is not permitted for roots greater than 2 inches in diameter without the approval of the Urban Forest Administrator in the Department of Public Works. No roots shall be cut within 36 inches of the tree trunk without the approval of the Urban Forest Administrator in the Department of Public Works. Alternatives to cutting roots greater than 2 inches in diameter must be considered.
  - c. In areas where the entire soil surface within the TPZ is pervious (i.e, grass, soil, mulch, pavers), the City reserves the right to mark TPZs with white paint for each protected tree located within the project limits and require the Contractor to place temporary fencing outside of each TPZ to protect the tree root structure.
- F. In the event that disturbance within the TPZ is unavoidable, the Contractor shall consult with the City before any construction begins to determine if the tree should be treated (i.e. improve aeration of the root zones through techniques such as vertical mulching, core aeration, radial aeration, mulching, fertilization, and/or irrigation as recommended by a certified arborist and performed in accordance with ANSI A300 arboriculture

standards), or removed and replaced. The City will mark trees which may be removed by the Contractor.

- G. In the event that existing trees are unintentionally damaged and the TPZ has been disturbed during construction, the Contractor shall immediately notify the City to determine if the tree shall be treated or removed and replaced. The City will mark trees which may be removed by the Contractor.
- H. In the event of tree removal, the Contractor shall plant or cause to be planted no fewer than two young trees each having a minimum caliper of two inches and being deemed appropriate by the City for the space and location in which each tree is to be planted. The Contractor shall plant replacement trees during the dormant season and water the replacement trees at a rate of 20 gallons/tree/week during the growing season (April through October) for a minimum of 1 year from the date of acceptance of plant material by the City.
- I. Trees on private property that are unintentionally damaged and the TPZ has been disturbed during construction shall either be replaced with no fewer than one two-inch caliper tree, or shall pay a compensatory payment acceptable to the tree owner for replacement.
- J. Tree Pruning, Planting and Removal Operations
  - 1. The Contractor shall obtain a tree work permit from the City for all tree work, including pruning, planting, and removal. Permits can be obtained by contacting Herb White (302-576-2582).
  - 2. All tree work, including pruning, planting and removal shall be completed by a Contractor with an ISA certified arborist directly supervising the work.
  - 3. All tree work must conform to ISA Standards.
  - 4. Quality and size of plants, spread of roots, and size of root balls shall be in accordance with ANSI Z-60 'American Standard for Nursery Stock' as published by the American Nursery and Landscape Association, Inc. City has the right to reject plant material deemed unacceptable.
  - 5. Replacement tree plantings must include tree stakes, mulch, and gator bags (Figure 2).
  - 6. Replacement trees will be planted in locations indicated by City and in the appropriate planting season (March through May or Sept through December).
  - 7. The Contractor shall be responsible for watering trees at a rate of 20 gallons/tree/week during the growing season (April through October) for a minimum of 1 year from the date of acceptance of plant material by the City.
  - 8. Trees are to be guaranteed by the installer to be in a vigorous growing condition for a minimum of 1 year from the date of acceptance of plant material by the City. If more than 30% of the crown is dead the tree must be replaced.

## Appendix A: Tree Protection and Planting Details

Figure 1. Tree Protection Zone Detail

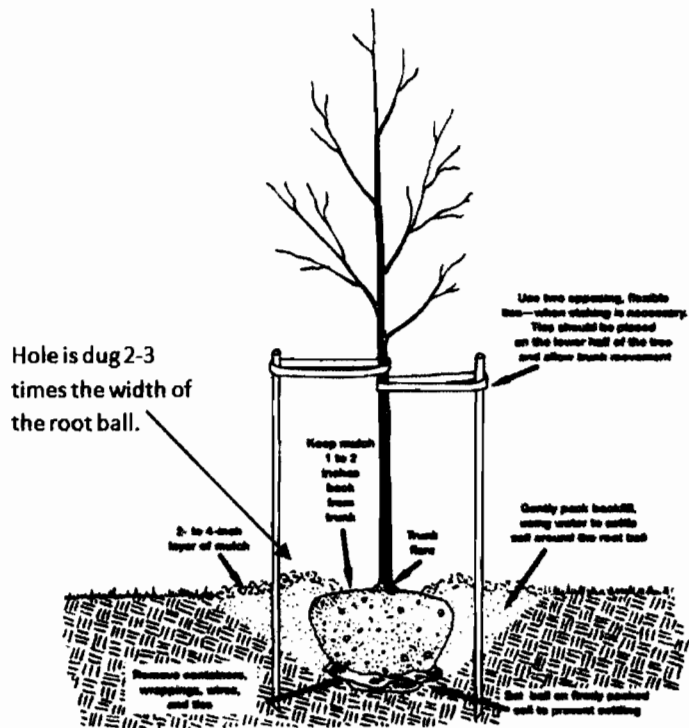
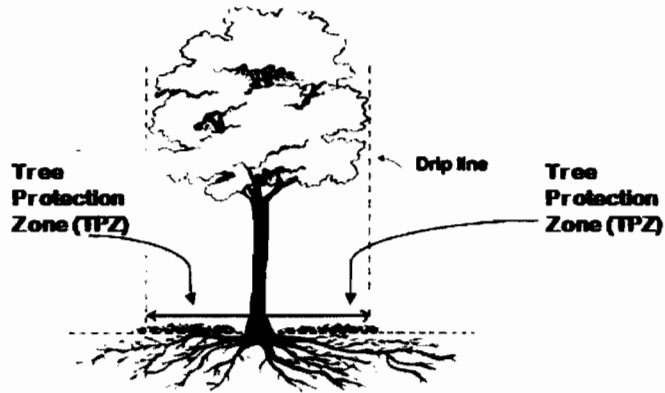

Appendix B: Wilmington Tree Permit

**Wilmington Tree Work Permit**

**Section 1** Date of Request: \_\_\_\_ / \_\_\_\_ / \_\_\_\_ Street address of requested tree work: \_\_\_\_\_

Planting Permit (Section 2)  
 Pruning Permit (Section 3)  
 Removal and Replacement Permit (Sections 2 and 4)  
 Tree pit expansion or creation

Location of tree on property: \_\_\_\_\_

**Section 2** **Planting** Number and species of tree(s) requested to be planted: \_\_\_\_\_

**Section 3** **Pruning** Number and species of tree(s) requested to be pruned: \_\_\_\_\_

Reason for pruning request: \_\_\_\_\_

Type of pruning:  
 Crown raising (raising lower limbs for pedestrian traffic)     Crown reduction (pruning upper limbs for traffic light, utility line, etc. clearance)  
 Crown thinning (no more than 25% of live crown)     Crown cleaning (removing deadwood for tree health and safety)  
 Root reduction (sidewalk interference)

**Section 4** **Removal** Number and species of tree(s) requested to be removed: \_\_\_\_\_

Reason for removal request: \_\_\_\_\_

*Please also fill out Section 2 with your selection of replacement tree(s).*

**Section 5** Name(s) of applicant(s): \_\_\_\_\_

Address of applicant(s): \_\_\_\_\_

Telephone: \_\_\_\_\_ Email: \_\_\_\_\_

Application is hereby made to conduct the operations selected above. If a permit is granted, I/we agree to arrange to have all work performed in accordance with all specifications, rules and standards set forth in Chapter 46, Vegetation, Wilmington Code.

Signature(s) of property owner(s): \_\_\_\_\_

Name of owner [if different from applicant(s)]: \_\_\_\_\_

City use only	DATE	Condition
Date of inspection: ____ / ____ / ____		Tree company doing the work: _____
<input type="checkbox"/> PERMIT APPROVED Initials: _____		Notes: _____
<input type="checkbox"/> PERMIT DENIED Initials: _____		
<input type="checkbox"/> INVENTORY UPDATED Initials: _____		

Return form to: City of Wilmington, Department of Public Works, Louis L. Redding City/County Building,  
 800 N. French St., Wilmington, DE 19801 - (P) 302.576.2582 (F) 302.571.6579  
 White Copy—Dept. of Public Works    Yellow Copy—DE Ctr. for Horticulture    Pink Copy—Homeowner

# **PROPOSAL FORM**

**CITY OF WILMINGTON, DELAWARE  
DEPARTMENT OF PUBLIC WORKS  
STREET PAVING, PHASE X**

**City of Wilmington, Delaware  
Department of Public Works  
Street Paving, Phase X  
Contract No. 22029PW**

**PROPOSAL FORM**

Date \_\_\_\_\_ Our City of Wilmington Business License No. \_\_\_\_\_

Attached hereto is a Certified Check or Bid Bond in the amount of:

\_\_\_\_\_ Dollars and \_\_\_\_\_ Cents.

This proposal is submitted with the knowledge that the Department of Finance, Division of Procurement and records reserves the right to reject any and all proposals when in its judgment it is in the best interest of the City of Wilmington to do so.

We, the undersigned, hereby agree to furnish and deliver, as per these specifications, the item(s) listed herein to the Department of Public Works, City of Wilmington, Delaware, and to complete the work within a period of ONE (1) year, or longer should any of the one-year options be exercised, after the contract has been awarded and the notice to proceed has been issued for each work order.

FIRM NAME AND ADDRESS: \_\_\_\_\_  
(Corporation, Partnership or Individual)

FEDERAL I.D. NUMBER: \_\_\_\_\_

TELEPHONE NUMBER: \_\_\_\_\_

FAX NUMBER: \_\_\_\_\_

EMAIL ADDRESS: \_\_\_\_\_

SIGNATURE: \_\_\_\_\_

TYPED NAME: \_\_\_\_\_

TITLE: \_\_\_\_\_

**City of Wilmington, Delaware  
 Department of Public Works  
 Street Paving, Phase X  
 Contract No. 22029PW  
 Proposal Form**

<u>ITEM NO.</u>	<u>DESCRIPTION</u>	<u>QUANTITY</u>	<u>UNIT PRICE</u>	<u>ITEM AMOUNT</u>
202004	UNDERCUT EXCAVATION, PATCHING	39 CY	\$ _____	\$ _____
211001	REMOVAL OF PORTLAND CEMENT CONCRETE PAVEMENT, CURB AND SIDEWALK	225 SY	\$ _____	\$ _____
301002	GRADED AGGREGATE BASE COURSE, TYPE B, PATCHING	34 CY	\$ _____	\$ _____
401005	SUPERPAVE TYPE C, PG64-22 (CARBONATE STONE)	11,666 TON	\$ _____	\$ _____
401007	SUPERPAVE TYPE C, PG76-22 (CARBONATE STONE)	3,685 TON	\$ _____	\$ _____
401029	SUPERPAVE TYPE C, PG 64-22, PATCHING	338 TON	\$ _____	\$ _____
401030	SUPERPAVE TYPE B, PG64-22, PATCHING	876 TON	\$ _____	\$ _____
401755	RECYCLED ASPHALT PAVEMENT MILLINGS FOR ROADWAY EDGE	113 TON	\$ _____	\$ _____
402000	BITUMINOUS CONCRETE PATCHING	21,237 SYIN	\$ _____	\$ _____
403000	BITUMINOUS CONCRETE AND/OR COLD LAID BITUMINOUS (TRM) CONCRETE	5 TON	\$ _____	\$ _____
504001	CRACK AND JOINT SEALING LESS THAN ¼ INCH WIDE	19,665 LF	\$ _____	\$ _____
602100	REPLACE DRAINAGE INLET GRATE(S)	6 EACH	\$ _____	\$ _____
602101	REPLACE DRAINAGE INLET FRAME(S)	6 EACH	\$ _____	\$ _____
602130	ADJUSTING AND REPAIRING EXISTING DRAINAGE INLET	12 EACH	\$ _____	\$ _____

**BID PROPOSAL**  
 Bidder's Initials \_\_\_\_\_



<u>ITEM NO.</u>	<u>DESCRIPTION</u>	<u>QUANTITY</u>	<u>UNIT PRICE</u>	<u>ITEM AMOUNT</u>
602131	ADJUSTING AND REPAIRING EXISTING DOUBLE DRAINAGE INLET	6 EACH	\$ _____	\$ _____
602132	ADJUSTING AND REPAIRING EXISTING MANHOLE	68 EACH	\$ _____	\$ _____
708001	GEATEXTILES, STABILIZATION	44 SY	\$ _____	\$ _____
710002	ADJUST WATER VALVE BOXES	156 EACH	\$ _____	\$ _____
710004	WATER VALVE BOX RISERS	80 EACH	\$ _____	\$ _____
710507	ADJUST AND REPAIR EXISTING SANITARY CLEANOUTS	18 EACH	\$ _____	\$ _____
710600	ADJUST CASTINGS, MONUMENT BOX AND OR LAMP HOLE	34 EACH	\$ _____	\$ _____
760010	PAVEMENT MILLING, BITUMINOUS CONCRETE PAVEMENT	188,913 SYIN	\$ _____	\$ _____
762000	SAW CUTTING BITUMINOUS PAVEMENT	5,358 LF	\$ _____	\$ _____
763000	INITIAL EXPENSE/DE-MOBILIZATION	1 LS	\$ _____	\$ _____
763531	WORK ORDER MOBILIZATION/DE-MOBILIZATION	20 EACH	\$ _____	\$ _____
801500	MAINTENANCE OF TRAFFIC, ALL INCLUSIVE	186 EADY	\$ _____	\$ _____
806001	TRAFFIC OFFICERS	178 HOUR	\$ _____	\$ _____
811001	FLAGGER, NEW CASTLE COUNTY, STATE	7,133 HOUR	\$ _____	\$ _____
811013	FLAGGER, NEW CASTLE COUNTY, STATE, OVERTIME	143 HOUR	\$ _____	\$ _____

<u>ITEM NO.</u>	<u>DESCRIPTION</u>	<u>QUANTITY</u>	<u>UNIT PRICE</u>	<u>ITEM AMOUNT</u>
817002	PERM PAVT STRIPING, SYM/LEG ALKYD-THERMOPLASTIC (CROSSWALKS)	8,606 SF	\$ _____	\$ _____
817003	TEMPORARY MARKINGS, PAINT, 4"	18.472 LF	\$ _____	\$ _____
817013	PERM PAVT STRIPING, EPOXY RESIN PAINT, WHITE/YELLOW, 5"	10,191 LF	\$ _____	\$ _____
817548	THERMOPLASTIC TRANSVERSE LINE, 16" (STOP BARS)	394 LF	\$ _____	\$ _____
846001	FURNISH AND INSTALL LOOP WIRE	79 LF	\$ _____	\$ _____
905004	INLET SEDIMENT CONTROL, DRAINAGE INLET	96 EACH	\$ _____	\$ _____
905004-A	REUSE INLET SEDIMENT CONTROL, DRAINAGE INLET	239 EACH	\$ _____	\$ _____
908003	TOPSOIL, 4"	282 SY	\$ _____	\$ _____
908014	PERMANENT GRASS SEEDING, DRY GROUND	282 SY	\$ _____	\$ _____
908020	EROSION CONTROL BLANKET	282 SY	\$ _____	\$ _____
			<b>Total:</b>	\$ _____

---

**Bid Cost (In Words)**

**City of Wilmington, Delaware  
Department of Public Works  
Street Paving, Phase X  
Contract No. 22029PW**

The bidder understands that the quantities listed in this Bid Proposal are approximate only and are for the purpose of comparing bids. Bidder understands and agrees that the quantities may be altered by the conditions found during the progress of the work and agrees that the owner may increase or decrease quantities of work to be done under any item. Bidder further agrees that in the case of discrepancies in the unit prices bid or in their extensions, the unit prices will be the basis for payment. Bidder further agrees that all work required by the contract, is covered by the unit prices bid herein and that no other payment will be allowed. Bidder further states that their official address for receiving communications is as shown on the first page of the Proposal Form.

The bidder plans to use the following subcontractors in the completion of the project:

**SUBCONTRACTORS LIST**

- |    |  |
|----|--|
| 1. | _____  |
|    | (Name) <span style="float: right;">(Work)</span> |
| 2. | _____  |
|    | (Name) <span style="float: right;">(Work)</span> |
| 3. | _____  |
|    | (Name) <span style="float: right;">(Work)</span> |
| 4. | _____  |
|    | (Name) <span style="float: right;">(Work)</span> |
| 5. | _____  |
|    | (Name) <span style="float: right;">(Work)</span> |
| 6. | _____  |
|    | (Name) <span style="float: right;">(Work)</span> |
| 7. | _____  |
|    | (Name) <span style="float: right;">(Work)</span> |

# **CONSENT OF SURETY**

**CITY OF WILMINGTON, DELAWARE  
DEPARTMENT OF PUBLIC WORKS  
STREET PAVING, PHASE X**

**CONSENT OF SURETY**

**DATE:** \_\_\_\_\_

**TO:** \_\_\_\_\_  
\_\_\_\_\_  
\_\_\_\_\_

**Gentlemen:**

We, the \_\_\_\_\_

\_\_\_\_\_  
**(Surety Company's Address)**

\_\_\_\_\_  
a Surety Company authorized to do business in the State of Delaware, hereby agree  
that if \_\_\_\_\_

**(Contractor)**

\_\_\_\_\_  
**(Address)**

is awarded Contract \_\_\_\_\_, we will write the required Performance  
and/or Labor and Materials Bond required by Paragraphs 6 and 7 of the  
Instructions to Bidders.

\_\_\_\_\_  
**Surety Company**

**BY:**

\_\_\_\_\_  
**Attorney-in-Fact**

City of Wilmington, Delaware  
Department of Public Works  
Street Paving, Phase X  
Contract No. 22029PW

PROPOSAL FORM

Date February 10, 2022 Our City of Wilmington Business License No. 2502

Attached hereto is a Certified Check or Bid Bond in the amount of:

10% of total bid amount Dollars and \_\_\_\_\_ Cents.

This proposal is submitted with the knowledge that the Department of Finance, Division of Procurement and records reserves the right to reject any and all proposals when in its judgment it is in the best interest of the City of Wilmington to do so.

We, the undersigned, hereby agree to furnish and deliver, as per these specifications, the item(s) listed herein to the Department of Public Works, City of Wilmington, Delaware, and to complete the work within a period of ONE (1) year, or longer should any of the one-year options be exercised, after the contract has been awarded and the notice to proceed has been issued for each work order.

FIRM NAME AND ADDRESS: Sam's Construction LLC  
(Corporation, Partnership or Individual)

P.O. Box 9827, Wilmington, DE 19809

FEDERAL I.D. NUMBER: 01-0594293

TELEPHONE NUMBER: 302-654-6542

FAX NUMBER: 302-654-6549

EMAIL ADDRESS: samsconstructionllc@verizon.net

SIGNATURE: 

TYPED NAME: Samuel Martinez

TITLE: Owner

**City of Wilmington, Delaware**  
**Department of Public Works**  
**Street Paving, Phase X**  
**Contract No. 22029PW**  
**Proposal Form**

<u>ITEM NO.</u>	<u>DESCRIPTION</u>	<u>QUANTITY</u>	<u>UNIT PRICE</u>	<u>ITEM AMOUNT</u>
202004	UNDERCUT EXCAVATION, PATCHING	39 CY	\$ <u>29.00</u>	\$ <u>1,131.00</u>
211001	REMOVAL OF PORTLAND CEMENT CONCRETE PAVEMENT, CURB AND SIDEWALK	225 SY	\$ <u>20.00</u>	\$ <u>4,500.00</u>
301002	GRADED AGGREGATE BASE COURSE, TYPE B, PATCHING	34 CY	\$ <u>40.00</u>	\$ <u>1,360.00</u>
401005	SUPERPAVE TYPE C, PG64-22 (CARBONATE STONE)	11,666 TON	\$ <u>80.00</u>	\$ <u>933,280.00</u>
401007	SUPERPAVE TYPE C, PG76-22 (CARBONATE STONE)	3,685 TON	\$ <u>80.00</u>	\$ <u>294,800.00</u>
401029	SUPERPAVE TYPE C, PG 64-22, PATCHING	338 TON	\$ <u>80.00</u>	\$ <u>27,040.00</u>
401030	SUPERPAVE TYPE B, PG64-22, PATCHING	876 TON	\$ <u>80.00</u>	\$ <u>70,080.00</u>
401755	RECYCLED ASPHALT PAVEMENT MILLINGS FOR ROADWAY EDGE	113 TON	\$ <u>25.00</u>	\$ <u>2,825.00</u>
402000	BITUMINOUS CONCRETE PATCHING	21,237 SYIN	\$ <u>3.00</u>	\$ <u>63,711.00</u>
403000	BITUMINOUS CONCRETE AND/OR COLD LAID BITUMINOUS (TRM) CONCRETE	5 TON	\$ <u>400.00</u>	\$ <u>2,000.00</u>
504001	CRACK AND JOINT SEALING LESS THAN 3/4 INCH WIDE	19,665 LF	\$ <u>2.00</u>	\$ <u>39,330.00</u>
602100	REPLACE DRAINAGE INLET GRATE(S)	6 EACH	\$ <u>400.00</u>	\$ <u>2,400.00</u>
602101	REPLACE DRAINAGE INLET FRAME(S)	6 EACH	\$ <u>400.00</u>	\$ <u>2,400.00</u>
602130	ADJUSTING AND REPAIRING EXISTING DRAINAGE INLET	12 EACH	\$ <u>800.00</u>	\$ <u>9,600.00</u>

<u>ITEM NO.</u>	<u>DESCRIPTION</u>	<u>QUANTITY</u>	<u>UNIT PRICE</u>	<u>ITEM AMOUNT</u>
602131	ADJUSTING AND REPAIRING EXISTING DOUBLE DRAINAGE INLET	6 EACH	\$ <u>900.00</u>	\$ <u>5,400.00</u>
602132	ADJUSTING AND REPAIRING EXISTING MANHOLE	68 EACH	\$ <u>800.00</u>	\$ <u>54,000.00</u>
708001	GEATEXTILES, STABILIZATION	44 SY	\$ <u>4.00</u>	\$ <u>176.00</u>
710002	ADJUST WATER VALVE BOXES	156 EACH	\$ <u>250.00</u>	\$ <u>39,000.00</u>
710004	WATER VALVE BOX RISERS	80 EACH	\$ <u>250.00</u>	\$ <u>20,000.00</u>
710507	ADJUST AND REPAIR EXISTING SANITARY CLEANOUTS	18 EACH	\$ <u>600.00</u>	\$ <u>10,800.00</u>
710600	ADJUST CASTINGS, MONUMENT BOX AND OR LAMP HOLE	34 EACH	\$ <u>600.00</u>	\$ <u>20,400.00</u>
760010	PAVEMENT MILLING, BITUMINOUS CONCRETE PAVEMENT	188,913 SYIN	\$ <u>.90</u>	\$ <u>170,021.70</u>
762000	SAW CUTTING BITUMINOUS PAVEMENT	5,358 LF	\$ <u>2.00</u>	\$ <u>10,716.00</u>
763000	INITIAL EXPENSE/DE-MOBILIZATION	1 LS	\$ <u>150,000.00</u>	\$ <u>150,000.00</u>
763531	WORK ORDER MOBILIZATION/DE-MOBILIZATION	20 EACH	\$ <u>2,000.00</u>	\$ <u>40,000.00</u>
801500	MAINTENANCE OF TRAFFIC, ALL INCLUSIVE	186 EADY	\$ <u>940.00</u>	\$ <u>174,840.00</u>
806001	TRAFFIC OFFICERS	178 HOUR	\$ <u>70.00</u>	\$ <u>12,460.00</u>
811001	FLAGGER, NEW CASTLE COUNTY, STATE	7,133 HOUR	\$ <u>55.00</u>	\$ <u>392,315.00</u>
811013	FLAGGER, NEW CASTLE COUNTY, STATE, OVERTIME	143 HOUR	\$ <u>70.00</u>	\$ <u>10,010.00</u>



<u>ITEM NO.</u>	<u>DESCRIPTION</u>	<u>QUANTITY</u>	<u>UNIT PRICE</u>	<u>ITEM AMOUNT</u>
817002	PERM PAVT STRIPING, SYM/LEG ALKYD-THERMOPLASTIC (CROSSWALKS)	8,606 SF	\$ <u>5.00</u>	\$ <u>43,030.00</u>
817003	TEMPORARY MARKINGS, PAINT, 4"	18,472 LF	\$ <u>1.00</u>	\$ <u>18,472.00</u>
817013	PERM PAVT STRIPING, EPOXY RESIN PAINT, WHITE/YELLOW, 5"	10,191 LF	\$ <u>2.00</u>	\$ <u>20,382.00</u>
817548	THERMOPLASTIC TRANSVERSE LINE, 16" (STOP BARS)	394 LF	\$ <u>10.00</u>	\$ <u>3,940.00</u>
846001	FURNISH AND INSTALL LOOP WIRE	79 LF	\$ <u>55.00</u>	\$ <u>4,345.00</u>
905004	INLET SEDIMENT CONTROL, DRAINAGE INLET	96 EACH	\$ <u>175.00</u>	\$ <u>16,800.00</u>
905004-A	REUSE INLET SEDIMENT CONTROL, DRAINAGE INLET	239 EACH	\$ <u>150.00</u>	\$ <u>35,850.00</u>
908003	TOPSOIL, 4"	282 SY	\$ <u>9.00</u>	\$ <u>2,538.00</u>
908014	PERMANENT GRASS SEEDING, DRY GROUND	282 SY	\$ <u>1.00</u>	\$ <u>282.00</u>
908020	EROSION CONTROL BLANKET	282 SY	\$ <u>4.00</u>	\$ <u>1,128.00</u>
			<b>Total:</b>	\$ <u>2,711,762.70</u>

Two Million Seven Hundred Eleven Thousand Seven Hundred Sixty Two Dollars and Seventy Cents  
**Bid Cost (In Words)**

**City of Wilmington, Delaware  
Department of Public Works  
Street Paving, Phase X  
Contract No. 22029PW**

The bidder understands that the quantities listed in this Bid Proposal are approximate only and are for the purpose of comparing bids. Bidder understands and agrees that the quantities may be altered by the conditions found during the progress of the work and agrees that the owner may increase or decrease quantities of work to be done under any item. Bidder further agrees that in the case of discrepancies in the unit prices bid or in their extensions, the unit prices will be the basis for payment. Bidder further agrees that all work required by thereof, is covered by the unit prices bid herein and that no other payment will be allowed. Bidder further states that their official address for receiving communications is as shown on the first page of the Proposal Form.

The bidder plans to use the following subcontractors in the completion of the project:

**SUBCONTRACTORS LIST**

- |    |                           |            |
|----|---------------------------|------------|
| 1. | Traffic Lines, Inc        | Striping   |
|    | (Name)                    | (Work)     |
| 2. | Byers Industrial Services | Electrical |
|    | (Name)                    | (Work)     |
| 3. |                           |            |
|    | (Name)                    | (Work)     |
| 4. |                           |            |
|    | (Name)                    | (Work)     |
| 5. |                           |            |
|    | (Name)                    | (Work)     |
| 6. |                           |            |
|    | (Name)                    | (Work)     |
| 7. |                           |            |
|    | (Name)                    | (Work)     |

# **DISADVANTAGED BUSINESS PROGRAM**

**CITY OF WILMINGTON, DELAWARE  
DEPARTMENT OF PUBLIC WORKS  
STREET PAVING, PHASE X**

**To Be Submitted with Bid**

CONTRACT: 22029PW

FORM DBE-1  
(Rev. 10/09)

**Failure to submit this completed form will be cause for rejection of your proposal**

Bidder acknowledges that he has read the D.B.E. goal provisions of the City for this fiscal year and that bidder will expend the dollar amount of the contract for D.B.E. subcontractors through the use of the following disadvantaged business enterprises, subject to the certification by the City, as subcontractors and that Bidder has made good faith efforts\* as evidenced by its listing of disadvantaged businesses that were contacted as detailed herein and on the following pages. (Must be completely filled out.)

**CITY OF WILMINGTON  
DISADVANTAGED BUSINESS ENTERPRISE ("D.B.E.")  
SUBCONTRACTOR LISTING**

D.B.E. Firm Name IRS Numbers	Mailing Address & Contact Number	Type of Service	Dollar Amount of Contract
Sam's Construction LLC 01-0594293	P.O. Box 9827, Wilmington, DE 19809 302-654-6542	Paving, Utility Adjustments	\$2,621,593.70
Total Dollar Amount to be Expended for Disadvantaged Business Enterprises	\$2,621,593.70		
Total Amount of Contract	\$2,711,762.70		
Percentage of Contract used for D.B.E.	97%		

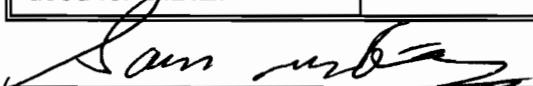
  
Name of Authorized Official of Bidder

Owner  
Title

Sam's Construction LLC  
Company

\*Good faith efforts shall be evidenced by listing each and every disadvantaged business enterprise (DBEs) contacted, showing the name and address of each, the names of contact persons, telephone numbers, sources used to identify DBEs, methods used to make contact, dates firms were contacted, responses, dates responses were received, type of subcontract, reasons for rejection, and estimated value of subcontract.

**To Be Submitted with Bid**

CONTRACT: 22029PW

FORM DBE-2  
(Rev. 10/09)

*Failure to submit this completed form will be cause for rejection of your proposal*

DBE Firm Name/Address	Contact Person(s) Email or Phone Number	Dates Contacted Initially and in Follow Up; Methods Used	Type of Subcontractor, plus Estimated Value	Reason for Rejection (If Firm Not Used) (If Bid "To High" Also Indicate Value)
1. Everyone Can Achieve, LLC 2010 Woodlawn Ave Wilmington, DE 19806	Mike Aiken 302-317-2275 mikeaiken1207@icloud.com	February 2, 2022 Email	Flaggers \$ 477,587.50	Bid "To High"
2.			\$	
3.			\$	

Were advertisements placed in general circulation media, trade association publications, and DBE media interested in DBE participation? If so, state details of the advertisement. If not, state why not.

No advertisements were posted. Sam's Construction LLC is a DBE company and all work will be done by us except striping and electrical.

What efforts were made to use the services of organizations that provide assistance in recruitment and placement of DBEs?

Checked the City of Wilmington DBE directory

The following are examples of actions that may not be used as justification by the contractor or bidder for failure to meet DBE participation goals:

1. Failure to contract with a DBE solely because the DBE was unable to provide performance and/or payment bonds.
2. Equipment idled by contract with DBE.
3. Rejection of a DBE because of its union or non-union status.

If more DBE firms have been contacted, please list with supplemental form(s) on additional pages.

*Failure to submit this completed form will be cause for rejection of your proposal*

**CITY OF WILMINGTON  
SUBCONTRACTOR LISTING  
(Do not include DBE Firms to be utilized)**

Subcontractor Name IRS Numbers	Mailing Address Contact Number or Email	Type of Service	Dollar Amount of Contract
Traffic Lines, Inc	5100 Asbury Rd, Farmingdale, NJ 07727 trafficl原因@gmail.com 732-919-3100	Striping	\$85,824.00
Byers Industrial Services	508 South Street, Bldg D, New Castle, DE shawn.allen@byersindustrial.com 302-420-6785	Electrical	\$4,345.00
Total Dollar Amount to Non-Disadvantaged Business Enterprises	\$90,169.00		
Total Amount of Contract	\$2,711,762.70		

Bidder acknowledges that he has identified all sub contractors that will be utilized as well as listing the amount of money that will be paid to each of the subcontractors as part of the contract (use additional pages if necessary).

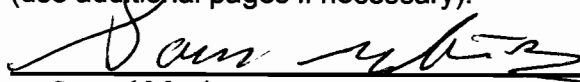
  
 \_\_\_\_\_  
 Samuel Martinez

**Name of Authorized Official of Bidder**  
 \_\_\_\_\_  
 Sam's Construction LLC

Owner  
 \_\_\_\_\_

**Title**  
 \_\_\_\_\_  
 February 10, 2022

**Company**  
 \_\_\_\_\_

**Date**  
 \_\_\_\_\_

**RESPONSIBLE CONTRACTOR  
CERTIFICATION**

**CITY OF WILMINGTON, DELAWARE  
DEPARTMENT OF PUBLIC WORKS  
STREET PAVING, PHASE X**

**Contractor/Subcontractor  
Responsibility Certification**

**Contractors:** The City of Wilmington Division of Procurement and Records must receive this executed form not later than at the time of bid submission. It may be submitted prior to bid submission for review.

**Subcontractors:** Must submit this form to requesting contractor.

**CONTRACTOR/SUBCONTRACTOR RESPONSIBILITY CERTIFICATION  
FOR DEPARTMENT OF PUBLIC WORKS CONTRACTS  
VALUED AT MORE THAN \$100,000**

Name of Company: Sam's Construction LLC

Address: Mailing: P.O. Box 9827, Wilmington, DE 19809

Physical: 1227 E 15th Street, Wilmington, DE 19802

Contract/Project Name: Street Paving, Phase X

Contract Number: 22029PW

As a condition of performing "City work" (all building or construction work or projects of any kind or nature as provided in City Code Sec. 2-651) for the City of Wilmington, Delaware, contractors and subcontractors (hereinafter referred to as "Bidders") must meet certain responsible contractor requirements and qualifications specified in the Wilmington City Code, Chapter 2, Article VI, Division 6, Subdivision III (Sec. 2-561 et seq.). Pursuant thereto, the Company named above certifies the following:

**PLEASE INITIAL EACH ITEM TO INDICATE COMPLIANCE  
(X's and check marks are *not* acceptable)**



SM1. The Bidder and its employees have all valid, effective licenses, registrations, or certificates required by federal, state, county, or local law, including, but not limited to, licenses, registrations, or certificates required to:

- a. do business in the City of Wilmington and the State of Delaware; and
- b. perform the contract work, including, but not limited to, licenses, registrations or certificates for any type of construction or maintenance trade work or specialty work which the Bidder proposes to self-perform.

SM2. The Bidder meets all:

- a. bonding requirements as required by the applicable law or contract specifications; and
- b. insurance requirements per applicable law or contract specifications, including general liability insurance, workers' compensation insurance, and unemployment insurance.

SM3. The Bidder has a satisfactory record of integrity in accordance with Sec. 2-537(4) of the City Code, which further states as follows:

The following provisions, while not exclusive, shall be sufficient to justify a finding of non-responsibility:

- a. failure to pay taxes and fees due and owing to the City;
- b. a conviction of the contractor or a principal officer thereof for commission of a criminal offense, as incident to obtaining or attempting to obtain a public contract or in the performance of such contract;
- c. a conviction, of the contractor or principal officer thereof, under state or federal statutes, for embezzlement, theft, forgery, bribery, falsification or destruction of records, receiving stolen property, or any other offense indicating a lack of business integrity or business honesty which currently, seriously and directly affects responsibility as a city contractor.

SM4. The Bidder has a satisfactory record of timely performance of City contracts in accordance with Sec. 2-537(3) of the City Code, which further states as follows:

Contractors who are seriously deficient in current contract performance, when the number of contracts and the extent of deficiency of each are considered, shall, in the absence of evidence to the contrary or circumstances properly beyond the control of the contractor, be presumed to be unable to meet this requirement. Past unsatisfactory performance due to failure to apply necessary

tenacity, or perseverance to do an acceptable job, shall be sufficient to justify a finding of non-responsibility.

SM 5. The Bidder has a satisfactory record of performance of contractual provisions in accordance with Sec. 2-537(5) of the City Code, which further states as follows:

Violation(s) of contract provisions of a character which justify a finding of non-responsibility include:

- a. deliberate failure without good cause to perform in accordance with the specifications provided in the contract;
- b. a recent record of failure to perform or of unsatisfactory performance in accordance with the terms of one or more contracts;
- c. in particular, failure to comply with prevailing wage and related federal, state, and city requirements;

provided, however, that failure to perform or unsatisfactory performance caused by acts beyond the control of the contractor shall not be considered to be a basis for a finding of non-responsibility.

SM 6. The Bidder has a satisfactory record of good faith efforts to achieve disadvantaged business enterprise participation in accordance with Sec. 2-537(8) of the City Code.

SM 7. The Bidder has not been debarred or suspended by any federal, state or local government agency or authority in the past three years.

SM 8. The Bidder has not defaulted on any project in the past three years.

SM 9. The Bidder has not had any type of business, contracting or trade license, registration, or other certification revoked or suspended in the past three years.

SM 10. The Bidder and its owners have not been convicted of any crime relating to the contracting business in the past ten years.

SM 11. The Bidder has not at any time been found in violation of any federal, state or local prevailing wage law.

SM 12. The Bidder has not within the past three years been found in violation of any law applicable to its contracting business, including, but not limited to, licensing laws, tax laws, prompt payment laws, wage and hour laws, environmental laws or others, where the result of such violation was the payment

of a fine, back pay damages or any other type of penalty in the amount of \$1,000 or more.

SM 13. The Bidder will pay all craft employees that it employs on the project the current wage rates and fringe benefits as required under applicable federal, state or local wage laws.

SM 14. All craft labor that will be employed by the Bidder for the project have completed at least the OSHA 10 hour training course for safety established by the U. S. Department of Labor, Occupational Safety & Health Administration.

SM 15. The Bidder will employ craft employees in all classifications and individual trades required to successfully perform the work related to the project.

SM 16. The Bidder has participated in a Class A Apprenticeship Program for the past twelve months, at a minimum, for each separate trade or classification in which it employs craft employees and shall continue to participate in such program or programs for the duration of the project. The twelve month participation requirement may be waived during the first year of implementation of this Ordinance; provided that the firm is participating in a Class A Apprenticeship Program at the time it submits its bid and submits information showing that the construction craft workers it plans to use have adequate skills to successfully perform the project. Once the Ordinance has been in effect for twelve months, i.e., September 4, 2013, a waiver of this requirement will no longer be available.

- a. for purposes of this section, a Class A Apprenticeship Program is an apprenticeship program that is currently registered with and approved by the U.S. Department of Labor or a state apprenticeship agency and has graduated apprentices to journeyman status for at least three of the past five years;
- b. to ensure compliance with this section, the Bidder shall provide, with this certification, a list of all trades or classifications of craft employees it will employ on the project and documentation verifying it participates in a Class A Apprenticeship Program for each trade or classification listed;
- c. in order to enhance the training of its workforce and to comply with this subsection, the firm must enroll a new person in a Class A Apprenticeship Program for each bid submitted to the City.

SM 17. The Bidder shall make all reasonable best efforts to ensure that fifteen percent (15%) of the workforce hired for the project, especially with respect to new workers recruited and hired for the project, includes City of Wilmington residents. To ensure compliance with this section, the Bidder will also make residency information on its workforce available to the City upon request.

SH 18. The Bidder has all other technical qualifications and resources, including equipment, personnel and financial resources, to perform the referenced contract, or will obtain same through the use of qualified, responsible contractors.

SH 19. The Bidder acknowledges that within seven (7) calendar days following the date of receipt of Notice of Intent to Award Contract, it will provide a list of subcontractors it plans to utilize for services in the performance of the contract. The list must include a brief description of the subcontractor's scope of work. In addition, each subcontractor providing services equaling or exceeding \$100,000 must provide executed Subcontractor Responsibility Certifications containing information equivalent to that required for the Bidder in the Contractor Responsibility Certification. Note: Bidder must initial this item regardless of the value of the subcontract services.

SH 20. If at any time during the past five (5) years the Bidder has controlled or has been controlled by another corporation, partnership or other business entity operating in the construction industry, it will disclose such facts by attaching a detailed statement to its Contractor Responsibility Certification explaining the nature of the relationship.

SH 21. The Bidder acknowledges that it shall be required to provide appropriate documentation of the conditions specified in this Contractor/Subcontractor Responsibility Certification. The Bidder also understands that the City of Wilmington may request additional information or documents at any time as the City of Wilmington deems necessary to evaluate the responsibility of Bidder. Bidder agrees to provide such additional information or supporting documentation for this Certification.

SH 22. If a Bidder fails to provide the Contractor Responsibility Certification required by this section, the Bidder shall be disqualified from bidding the contract. If a Bidder fails to provide other information or documentation required by the City of Wilmington, it may be disqualified from being awarded the contract.

SH 23. The Bidder shall notify the City within seven days of any material changes to all matters attested to in this certification.

Under the penalty of perjury, the Bidder's authorized representative hereby certifies that all information included in the Contractor Responsibility Certification or otherwise submitted for purposes of determining the Bidder's status as a responsible contractor is true, complete and accurate and that he/she has knowledge and authority to verify the information in this certification or otherwise submitted on behalf of the Bidder by his or her signature below.



Authorized Signature

February 10, 2022

Date

Samuel Martinez

Print Name

Owner

Title

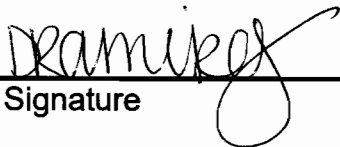

Witness Signature

February 10, 2022

Date

PLEASE SUBMIT **SIGNED ORIGINAL** VERSION OF THIS FORM TO:

**CITY OF WILMINGTON  
DEPARTMENT OF FINANCE, DIVISION OF PROCUREMENT  
LOUIS REDDING CITY COUNTY BUILDING  
800 N. FRENCH STREET, 5<sup>TH</sup> FLOOR  
WILMINGTON, DE019801**

Questions regarding the this form can be sent to  
[procurement@wilmingtonde.gov](mailto:procurement@wilmingtonde.gov) or call 302.576.2423

# City of Wilmington



**MICHAEL S. PURZYCKI**  
Mayor

## BID RESULTS

Division of Procurement & Records  
Louis L. Redding City/County Building  
800 N. French Street, 5<sup>th</sup> Floor, Wilmington, DE 19801

### 22029PW STREET PAVING PHASE 10

<b>Vendor</b>	<b>Bid</b>
Brandywine Const. Co. Inc.	\$3,476,623.90
Eastern States Const. Serv. Inc.	\$2,879,771.57
Diamond Materials LLC	\$2,787,125.20
Allan Myers	\$2,715,000.00
Grassbusters Landscaping Co Inc	\$2,832,940.00
Greggo & Ferrara Inc	\$3,355,774.98
Harmony Construction	\$2,915,547.60
Sam's Construction LLC **	\$2,711,762.70

\*\* After the zoom call concluded but before the Purchasing and Auditing Department had left the conference room one of the guards from the first floor came in and presented us with a bid. This bid was from Sam's Construction LLC. The guard indicated that it was delivered at 12:30 PM and the guard directed the bid to be placed in a locked Finance drop box. This was the incorrect box; however, the bid was clearly in the possession of the City of Wilmington long before the 3:00 PM deadline.



**DEPARTMENT OF PUBLIC WORKS**  
*City of Wilmington, Delaware*

**MEMORANDUM**

To: Phil Ceresini  
Procurement and Records

From: Vincent R. Carroccia  
Deputy Commissioner

Date: February 15, 2022

Re: Contract 22029PW – Street Paving Phase X

I am recommending award of Contract 22029PW – Street Paving Phase X in the amount of \$2,711,762.70 to Sam's Construction, LLC as the lowest bidder on this contract. Detailed bid analysis was provided by The Kercher Group and was sent separately.

Approved:

  
\_\_\_\_\_  
Kelly A. Williams, Commissioner



**Leading Providers of Infrastructure  
Asset Management and Engineering  
Services since 1994**

Mr. Vincent Carroccia  
Louis L. Redding  
City/County Bldg., 6th Floor  
800 N. French Street  
Wilmington, DE 19801-3537

February 15, 2022

**RE:** Street Paving Phase X  
Contract No. 22029PW  
Bid Evaluation

Dear Mr. Carroccia:

Eight (8) bids were received for the referenced project on February 10, 2022. A review of the bids has been performed. The attached spreadsheet contains an analysis of the bid. Total bids are as follows.

	Total	% of Eng. Est.
Engineer's Estimate	\$3,127,386.09	
Sam's Construction, LLC	\$2,711,762.70	86.7%
Allan Myers, LP	\$2,715,000.00	86.8%
Grass Busters Landscaping Co. Inc.	\$2,832,940.00	90.6%
Diamond Materials, LLC.	\$2,833,259.02	90.6%
Harmony Construction, Inc.	\$2,915,547.60	93.2%
Eastern States Const. Serv., Inc.	\$3,064,306.85	98.0%
Greggo & Ferrara, Inc.	\$3,355,774.98	107.3%
Brandywine Construction Co., Inc.	\$3,476,623.90	111.2%

The major items of work are highlighted on the spreadsheet. A major item is defined as an item that is more than 10% of the total bid. This bid contains three major items. They are Item 401005 Superpave Type C, PG 64-22 (carbonate stone) which is 34.4% of the total bid, Item 401007 Superpave Type C, PG 76-22 (carbonate stone) which is 10.9% of the bid total and Item 811001 Flagger, New Castle County, State which is 14.5% of the bid. The bid prices for these three items are within an acceptable price range. The contractor bid total for these three items is \$1,620,395.00 compared to \$1,980,295.80 in the Engineers estimate.

Bid errors:

Sam's Construction LLC bid contained a math error for item 602136 Adjusting and Repairing Existing Manhole the item total on their bid form shows \$54,000.00 it should read \$54,400.00. The sum of all items included the correct total for this item and has no bearing on bid total.

**THE KERCHER GROUP, INC. a Mott MacDonald Co.**

**www.kerchergroup.com | 254 Chapman Rd., Suite 202, Newark, DE 19702 | 302-894-1098**



Diamond Materials LLC bid contained a error for item 817003 Temporary Markings, Paint, 4". They used quantity of 18.472 LF which is incorrect although show on the bid proposal as such. Quantity should read 18,472 LF. Diamonds bid was adjusted using the correct total for this item and recalculated to be \$2,833,259.02.

Eastern States Const. Serv., Inc. bid contained the same error for item 817003 Temporary Markings, Paint, 4". They used quantity of 18.472 LF which is incorrect although show on the bid proposal as such. Quantity should read 18,472 LF. Eastern States Const. Serv., Inc. bid was adjusted using the correct total for this item and recalculated to be \$3,064,306.85. This contractor questioned this quantity via email on February 2, 2022, and a response sent clarifying this quantity was provided the same day.

There is an issue with Allan Myers bid price of \$1.00 hour for items 811001 and 811013 Flaggers. DBE -1 form reports flaggers subcontracted at \$ 256,000.00. The contract labor rates for flaggers are \$46.69 hour with a quantity of 7,133 hours or a total of \$333,039.77. The bid is inconsistent as it does not equal the reported amount in the DBE-1 form and does not cover costs labor required.

The bid of \$2,711,762.70 submitted by Sam's Construction, LLC. has been reviewed and is considered acceptable. At this time, I recommend award of the project to the low bidder, Sam's Construction, LLC P.O. Box 9827, Wilmington DE 19809.

Please contact me should you have and questions or comments.

Sincerely,



Michael Baiocco, Project Manager

cc: Philip Ceresini, Purchasing Agent

Attachment: Bid Analysis Spreadsheet

City of Wilmington, DE  
 Street Parking, Phase X  
 Project No. 29029PW  
 Bid Evaluation

ITEM	DESCRIPTION	QTY	UNIT	UNIT COST	COST	Sam's Construction LLC	UNIT COST	COST	Alan Myers, LP	UNIT COST	COST	GrassBusters Landscaping Co. Inc.	UNIT COST	COST	Diamond Materials LLC	UNIT COST	COST	Hannory Construction	UNIT COST	COST
401020	SUPERPAVE, TYPE C, PG 64-22 PAVING	318	TON	102.10	\$34,509.80	80.00	27,040.00	90.40	30,555.20	90.00	30,420.00	105.00	33,490.00	110.50	35,490.00	110.50	35,490.00	60.00	35,490.00	37,340.00
401030	SUPERPAVE, TYPE B, PG 64-22 PAVING	876	TON	96.10	\$84,183.60	80.00	70,160.00	103.00	90,288.00	85.00	74,460.00	98.00	85,848.00	98.00	85,848.00	98.00	85,848.00	93.85	82,212.60	82,212.60
401555	RECYCLED ASPHALT PAVEMENT MILLINGS FOR ROADWAY USE	113	TON	51.25	\$5,791.25	25.00	2,825.00	41.05	4,688.65	20.00	2,260.00	37.00	4,181.00	35.00	3,995.00	37.00	4,181.00	35.00	3,995.00	3,995.00
402000	BITUMINOUS CONCRETE PAVING	21,227	SYN	2.14	\$45,447.18	3.00	63,711.00	3.20	67,928.40	2.00	42,474.00	1.65	35,041.05	1.95	41,412.15	1.65	35,041.05	1.95	41,412.15	41,412.15
404000	BITUMINOUS CONCRETE AND/OR COLD LAID BITUMINOUS (G)	5	TON	122.00	\$610.00	400.00	2,000.00	150.00	750.00	10.00	50.00	135.00	62.00	95.00	62.00	95.00	95.00	95.00	95.00	95.00
544001	CRACK AND JOINT SEALING LESS THAN 3/4 INCH WIDE	19,665	LF	2.82	\$55,455.90	2.00	\$39,330.00	0.75	14,748.75	1.50	29,497.50	1.35	26,547.75	1.30	25,564.50	1.35	26,547.75	1.30	25,564.50	25,564.50
602100	REPLACE DRAINAGE INLET (FRAMES)	6	EACH	205.00	\$1,230.00	400.00	2,400.00	420.00	2,520.00	350.00	2,100.00	2,100.00	3,150.00	2,500.00	1,500.00	3,150.00	2,500.00	1,500.00	1,500.00	1,500.00
602101	REPLACE DRAINAGE INLET (FRAMES)	12	EACH	1,557.50	\$18,690.00	800.00	2,400.00	1,540.00	18,480.00	1,250.00	15,600.00	1,250.00	15,600.00	1,250.00	15,600.00	1,250.00	15,600.00	1,075.00	12,900.00	12,900.00
602112	ADJUSTING AND REPAIRING EXISTING DOUBLE DRAINAGE IN	6	EACH	2,091.00	\$12,546.00	900.00	\$5,400.00	2,050.00	\$12,300.00	1,500.00	\$9,000.00	1,650.00	\$9,900.00	1,650.00	\$9,900.00	1,650.00	\$9,900.00	2,000.00	\$12,000.00	12,000.00
602113	ADJUSTING AND REPAIRING EXISTING MANHOLE	48	EA	1,180.00	\$56,640.00	800.00	\$73,600.00	1,180.00	\$56,640.00	800.00	\$73,600.00	900.00	\$81,000.00	900.00	\$81,000.00	900.00	\$81,000.00	1,000.00	\$90,000.00	68,000.00
708001	GEOTEXTILES STABILIZATION	44	SY	24.62	\$1,083.28	4.00	176.00	30.10	1,324.40	10.00	440.00	34.00	1,496.00	10.00	440.00	34.00	1,496.00	575.00	\$5,750.00	89,700.00
710002	ADJUST WATER VALVE BOXES	156	EACH	537.00	\$83,772.00	250.00	\$137,500.00	540.00	\$292,200.00	84,240.00	\$44,664.00	550.00	\$292,200.00	84,240.00	\$44,664.00	550.00	\$292,200.00	84,240.00	\$44,664.00	89,700.00
710004	WATER VALVE BOX RISERS	80	EA	194.40	\$15,552.00	250.00	\$62,500.00	56.00	\$4,480.00	17,820.00	\$1,600.00	80.00	\$6,400.00	300.00	\$2,400.00	80.00	\$6,400.00	300.00	\$2,400.00	24,000.00
710050	ADJUST AND REPAIR EXISTING SANITARY CLEANOUTS	14	EA	689.00	\$9,646.00	600.00	\$42,000.00	840.00	\$67,200.00	1,782.00	\$13,892.40	900.00	\$6,300.00	900.00	\$6,300.00	900.00	\$6,300.00	850.00	\$5,200.00	15,300.00
710600	PAVEMENT MILLING BITUMINOUS CONCRETE PAVEMENT	184,913	SYN	1.78	\$328,251.14	0.90	\$166,427.70	2.15	\$397,269.75	2,520.00	\$63,504.00	4,066.95	\$103,709.20	3,400.00	\$8,560.00	900.00	\$3,060.00	745.00	\$2,997.50	25,330.00
760010	PAVEMENT MILLING BITUMINOUS CONCRETE	5,336	LF	1.05	\$5,602.80	2.00	\$10,716.00	0.50	\$2,679.00	1.50	\$7,538.50	2.80	\$14,688.75	0.75	\$3,000.00	2.80	\$14,688.75	1.25	\$6,397.50	6,397.50
765000	INITIAL EXPENSE/DEMOBILIZATION	1	LS	70,106.11	\$70,106.11	150,000.00	\$150,000.00	111,344.74	\$111,344.74	51,904.50	\$51,904.50	1,000.00	\$1,000.00	1,000.00	\$1,000.00	1,000.00	\$1,000.00	60,000.00	\$60,000.00	60,000.00
765001	WORK ORDER MOBILIZATION / DEMOBILIZATION	20	EA	1,406.00	\$28,120.00	2,000.00	\$28,000.00	1,000.00	\$14,000.00	1,000.00	\$14,000.00	20,000.00	\$28,000.00	20,000.00	\$28,000.00	20,000.00	\$28,000.00	2,500.00	\$35,000.00	20,000.00
801500	MAINTENANCE OF TRAFFIC, ALL INCLUSIVE	186	EA	460.20	\$85,597.20	70.00	\$12,600.00	1.00	\$186.00	186.00	\$85,597.20	1.00	\$186.00	186.00	\$85,597.20	1.00	\$186.00	186.00	\$85,597.20	46,500.00
806001	TRAFFIC OFFICERS	178	HO	70.77	\$12,597.06	70.00	\$12,460.00	65.00	\$4,525.00	11,370.00	\$9,790.00	77.00	\$5,411.00	77.00	\$5,411.00	77.00	\$5,411.00	71.50	\$5,072.50	12,727.00
811013	FLAGGER, NEW CASTLE COUNTY, STATE OVERTIME	143	HO	71.80	\$10,267.40	70.00	\$10,100.00	1.00	\$143.00	71.00	\$10,153.00	1.05	\$150.15	1.05	\$150.15	1.05	\$150.15	1.05	\$150.15	150.15
817002	PERM PAV STRIPING, SYM, 150 ALKYL-THERMOPLASTIC (C)	8,606	SF	5.98	\$51,463.88	5.00	\$43,030.00	7.30	\$62,823.80	6.95	\$59,811.70	7.00	\$63,242.00	8.25	\$70,995.50	7.00	\$63,242.00	8.25	\$70,995.50	70,995.50
817003	TEMPORARY MARKINGS, PAINT, P	10,191	LF	0.45	\$4,586.25	1.00	\$18,472.00	0.58	\$5,911.70	1.00	\$1,716.00	2.50	\$4,680.00	0.65	\$2,752.50	2.50	\$4,680.00	0.65	\$2,752.50	12,006.80
817013	PERMANENT PAVEMENT STRIPING, EPOXY RESIN PAINT, WHI	10,191	LF	1.39	\$14,165.49	2.00	\$20,382.00	1.65	\$16,815.15	1.55	\$15,796.05	2.50	\$25,477.50	1.80	\$18,343.80	2.50	\$25,477.50	1.80	\$18,343.80	18,343.80
817548	THERMOPLASTIC TRANSPARENT LINE, 16" (STOP BARS)	394	LF	6.14	\$2,419.16	10.00	\$3,940.00	6.90	\$2,718.60	6.60	\$2,664.00	7.00	\$2,780.00	7.00	\$2,780.00	7.00	\$2,780.00	6.00	\$2,460.00	3,940.00
846001	FURNISH AND INSTALL LOOP WIRE	79	EA	23.60	\$1,864.40	55.00	\$4,345.00	26.20	\$2,669.80	35.00	\$2,765.00	15.00	\$1,185.00	20.00	\$1,580.00	15.00	\$1,185.00	20.00	\$1,580.00	1,580.00
905004	INLET SEDIMENT CONTROL, DRAINAGE INLET	96	EA	119.80	\$11,500.80	175.00	\$16,800.00	110.00	\$10,560.00	100.00	\$9,600.00	145.00	\$13,920.00	100.00	\$9,600.00	145.00	\$13,920.00	75.00	\$7,125.00	9,600.00
905004-A	REUSE INLET SEDIMENT CONTROL, DRAINAGE INLET	242	SY	75.00	\$17,925.00	9.00	\$35,838.00	111.00	\$7,971.00	26,520.00	\$2,652.00	60.00	\$4,500.00	95.00	\$7,125.00	60.00	\$4,500.00	95.00	\$7,125.00	17,925.00
908001-A	TOP-SOIL, 4"	513	SF	5.13	\$2,631.66	1.00	\$513.00	4.20	\$2,163.60	5.00	\$2,565.00	8.50	\$43,625.00	5.00	\$2,565.00	8.50	\$43,625.00	35.00	\$179,625.00	17,962.50
908020	PERMANENT GRASS SEEDING, DRY GRASS	282	SY	2.05	\$578.10	1.00	\$282.00	2.60	\$733.20	1.00	\$282.00	3.00	\$846.00	3.50	\$945.00	3.50	\$945.00	3.50	\$945.00	987.00
908020	EROSION CONTROL, BLANKET	282	SY	3.50	\$1,012.58	4.00	\$1,404.00	2.60	\$733.20	3.00	\$846.00	3.50	\$945.00	3.50	\$945.00	3.50	\$945.00	3.50	\$945.00	987.00
Year 1 Total:				\$3,127,386.09		\$2,711,782.70		\$2,715,000.00		\$2,832,940.00		\$2,832,940.00		\$2,833,259.02		\$2,787,125.20		\$2,915,547.60		\$2,915,547.60

Bid Bond		% of Bidders Est	% of Low Bid
		100.0%	113.3%
Sub Contractors	X	86.7%	100.0%
DBE	X		
Responsible Contractor	X		
Consent of Surety	X		
DE Business License	X		
City Business License	X		

PREPARED BY: THE KERCHER GROUP, INC. a Mart MacDonald Co.

City of Wilmington, DE  
 Street Paving, Phase X  
 Project No. 29029PW  
 Bid Evaluation

ITEM	DESCRIPTION	QTY	UNIT	Eastern States Const Serv. Inc.	Greggio & Ferraro, Inc.	Brandtwyne Construction Co. Inc.	% of Bid	A/R Price	A/R Price Est
401029	SUPERPAVE, TYPE C, PG 64-22, PATCHING	318	TON	\$ 99,000	\$ 31,462.00	\$ 110,000	1.0%	\$ 98.56	\$ 31,246.55
401030	SUPERPAVE, TYPE B, PG 64-22, PATCHING	876	TON	\$ 95,000	\$ 83,220.00	\$ 83,000	2.6%	\$ 92.48	\$ 81,013.58
401031	RECYCLED ASPHALT PAVEMENT MILLINGS FOR ROADWAY	113	TON	\$ 50,000	\$ 5,650.00	\$ 40,000	0.1%	\$ 39.07	\$ 4,414.77
402000	BITUMINOUS CONCRETE PATCHING	21,237	SYDN	\$ 1,000	\$ 21,237.00	\$ 2,300	2.3%	\$ 2.18	\$ 46,523.21
403000	CRACK AND JOINT SEALING LESS THAN 1/4 INCH WIDE	5	TON	\$ 150,000	\$ 750.00	\$ 250,000	0.1%	\$ 184.38	\$ 921.88
504001	REPLACE DRAINAGE INLET (GRATE/S)	19,665	LF	\$ 1.50	\$ 29,497.50	\$ 3.00	1.5%	\$ 1.96	\$ 38,469.66
602101	ADJUSTING AND REPAIRING EXISTING DRAINAGE INLET	6	EACH	\$ 350,000	\$ 2,100.00	\$ 430,000	0.1%	\$ 359.38	\$ 2,156.25
602111	ADJUSTING AND REPAIRING EXISTING DOUBLE DRAINAGE IN	12	EACH	\$ 1,500,000	\$ 13,800.00	\$ 970,000	0.4%	\$ 543.75	\$ 3,262.50
602131	ADJUSTING AND REPAIRING EXISTING MANHOLE	6	EACH	\$ 2,000,000	\$ 12,000.00	\$ 1,300,000	0.2%	\$ 1,705.00	\$ 10,230.00
708001	ADJUSTING AND REPAIRING EXISTING MANHOLE	68	EA	\$ 1,050,000	\$ 71,400.00	\$ 970,000	2.0%	\$ 996.88	\$ 67,787.50
710002	WATER VALVE BOXES	156	EACH	\$ 25,000	\$ 3,900.00	\$ 15,000	0.0%	\$ 17.95	\$ 789.80
710004	WATER VALVE BOXES	80	EA	\$ 70,000	\$ 5,600.00	\$ 430,000	0.7%	\$ 467.75	\$ 72,589.00
710005	ADJUST CASTINGS, MONUMENT BOX AND OR LAMP HOLE	18	EA	\$ 700,000	\$ 12,600.00	\$ 860,000	0.4%	\$ 670.88	\$ 12,075.75
760010	PAVEMENT MILLING, BITUMINOUS CONCRETE PAVEMENT	34	EA	\$ 730,000	\$ 24,870.00	\$ 860,000	0.8%	\$ 664.38	\$ 22,588.75
762000	SAW CUTTING, BITUMINOUS CONCRETE	188,913	SYDN	\$ 1.25	\$ 236,639.75	\$ 2.10	0.9%	\$ 1.83	\$ 286,537.27
763000	INITIAL EXPENSE/DE-MOBILIZATION	1	LS	\$ 30,000,000	\$ 30,000.00	\$ 20,000,000	5.5%	\$ 34,093.78	\$ 54,093.78
763511	WORK ORDER MOBILIZATION/DE-MOBILIZATION	20	EA	\$ 500,000	\$ 10,000.00	\$ 3,000,000	1.5%	\$ 1,085.88	\$ 21,717.50
801500	MAINTENANCE OF TRAFFIC ALL INCLUSIVE	186	EA	\$ 100,000	\$ 18,600.00	\$ 1,000,000	0.9%	\$ 382.75	\$ 71,191.50
806001	TRAFFIC OFFICERS	178	HOURLY	\$ 65,000	\$ 11,570.00	\$ 85,000	0.9%	\$ 75.31	\$ 13,049.65
811013	FLAGGER, NEW CASTLE COUNTY, STATE OVERTIME	143	HOURLY	\$ 90,000	\$ 12,870.00	\$ 71,000	0.9%	\$ 47.01	\$ 6,722.79
811002	PERMANENT PAVING, SYM. LEGAL/STD-THERMOPLASTIC (C)	8,666	LF	\$ 8,000	\$ 68,848.00	\$ 8,035	1.6%	\$ 7.26	\$ 62,447.29
811003	PERMANENT PAVING, SYM. LEGAL/STD-THERMOPLASTIC (C)	8,666	LF	\$ 10,000	\$ 86,660.00	\$ 9.59	0.7%	\$ 7.05	\$ 77,890.69
811013	PERMANENT PAVING STRIPING, EPOXY RESIN PAINT, WHITE	10,191	LF	\$ 1,875	\$ 18,853.25	\$ 1,710	0.8%	\$ 1.89	\$ 19,299.21
811548	THERMOPLASTIC TRANSVERSE LINE, 16" (8" TOP BARS)	394	LF	\$ 8.00	\$ 3,152.00	\$ 7.10	0.1%	\$ 7.92	\$ 3,119.99
840001	FURNISH AND INSTALL LOOP WIRE	79	LF	\$ 45,000	\$ 3,555.00	\$ 24,000	0.0%	\$ 35.28	\$ 2,828.75
905004-A	INLET SEWER/STREET CONTROL, DRAINAGE INLET	239	EA	\$ 80,000	\$ 19,120.00	\$ 270,000	0.0%	\$ 145.63	\$ 13,980.00
909003	RELIEF INLET SEDIMENT CONTROL, DRAINAGE INLET	282	SY	\$ 15,000	\$ 4,230.00	\$ 10,000	1.3%	\$ 112.63	\$ 26,917.38
909014	PERMANENT GRASS SEEDING, DRY GROUND	282	SY	\$ 3,000	\$ 846.00	\$ 8,900	0.0%	\$ 2.93	\$ 4,282.88
909020	EROSION CONTROL BLANKET	282	SY	\$ 5,000	\$ 1,410.00	\$ 20,000	0.0%	\$ 5.98	\$ 1,686.61
				\$ 3,064,306.85	\$ 3,355,774.98	\$ 3,476,623.90			\$ 2,988,151.88
				\$ 2,879,771.57					

Item	Req'd	Est	% of Low Bid	Req'd	Est	% of Low Bid
Sub-Contractors	X	X		X	X	
DBE	X	X		X	X	
Responsible Contractor	X	X		X	X	
Consent of Surety	X	X		X	X	
DBE Business License						
City Business License						

## CERTIFICATE OF AWARD OF CONTRACT

I hereby certify that Contract No. 22029PW is on this 15th of March 2022 awarded to Sam's Construction, LLC as per Proposal dated 2/10/22 and that this award is made in compliance with Wilm. Code (Charter), Section 8-200, to wit:

1. Plans and specifications for the work, supplies, or materials were filed with the Department of Finance, Division of Procurement and Records for public inspection on 1/6/22.
2. The advertisement calling for sealed bids on this contract was published in the News Journal on 1/6/22 & 1/13/22 stated that bids would be opened at 3:00 p.m. on 2/10/22
3. All sealed bids received were publicly opened in the office of the Department of Finance, Division of Procurement and Records in the presence of the City Auditor and Department not represented desiring to make the purchase at 3:00 p.m. on 2/10/22. Other persons present at the opening of the bids were: Phil Ceresini & Michael Maldonado
4. Bids were submitted by the following contractors in the following amounts:

<u>Contractor</u>	<u>Address</u>	<u>Date of Bid</u>	<u>Cost</u>
Sam's Construction, LLC	Wilmington, DE	2/10/2022	\$2,711,762.70
Brandywine Construction Co.,	New Castle, DE	2/10/2022	\$3,476,623.90
Eastern States Const Serv	Wilmington, DE	2/10/2022	\$2,879,771.57
Diamond Materials LLC	Newport, DE	2/10/2022	\$2,787,125.20
Allan Myers	Worcester, PA	2/10/2022	\$2,715,000.00
Grassbusters Landscaping, Co	Newark, DE	2/10/2022	\$2,832,940.00
Greggo & Ferrara, Inc	New Castle, DE	2/10/2022	\$3,355,774.98
Harmony Construction	Wilmington, DE	2/10/2022	<del>\$2,711,762.70</del>
			<b># 2,915,547.60</b>

5. City License Number \_\_\_\_\_

6. Upon recommendation of Deputy Commissioner of Public Works and after due consideration, I determined that the contractor to whom this award is made was the lowest responsible bidder. In support of this determination, I have received the following written recommendations, which are on file at my office:

<u>Author</u>	<u>Employment Position</u>	<u>Date</u>
Vincent R. Carroccia	Deputy Commissioner	2/15/22

  
\_\_\_\_\_  
Department of Finance, Division of Procurement

# Delaware

The First State

Page 1

I, JEFFREY W. BULLOCK, SECRETARY OF STATE OF THE STATE OF DELAWARE, DO HEREBY CERTIFY "SAM'S CONSTRUCTION, L.L.C." IS DULY FORMED UNDER THE LAWS OF THE STATE OF DELAWARE AND IS IN GOOD STANDING AND HAS A LEGAL EXISTENCE SO FAR AS THE RECORDS OF THIS OFFICE SHOW, AS OF THE TWENTY-FIFTH DAY OF MARCH, A.D. 2022.

AND I DO HEREBY FURTHER CERTIFY THAT THE SAID "SAM'S CONSTRUCTION, L.L.C." WAS FORMED ON THE TWENTIETH DAY OF DECEMBER, A.D. 2001.

AND I DO HEREBY FURTHER CERTIFY THAT THE ANNUAL TAXES HAVE BEEN PAID TO DATE.



  
Jeffrey W. Bullock, Secretary of State

3474030 8300

SR# 20221164622

You may verify this certificate online at [corp.delaware.gov/authver.shtml](http://corp.delaware.gov/authver.shtml)

Authentication: 203011105

Date: 03-25-22

FORM OF BOND

Know All Men by These Presents, That We, \_\_\_\_\_

SAM'S CONSTRUCTION, LLC

of P.O. BOX 9827 WILMINGTON, DE 19809-----

as principal, and Great Midwest Insurance Company

800 Gessner Road, Suite 600, Houston TX77024

as Surety, legally authorized to do business in the State of Delaware, are held and firmly bound unto the City of Wilmington, a municipal corporation of the State of Delaware,(hereinafter sometimes referred to as the Obligee), in the amount of **Two Million Seven Hundred Eleven Thousand Seven Hundred Sixty Two ----- 70/100----- Dollars (\$2,711,762.70 )** to be paid to the said obligee, the City of Wilmington, for which payment, well and truly to be made, we do bind ourselves, our and each and every of our heirs, executors administrators, successors and assigns, jointly and severally, for and in the whole, firmly by these presents.

Sealed with our seals.

Dated the 15th day of March, 2022

Now, the condition of this obligation is such, that if the above bounded Principal who has been awarded by the Department of Finance, Division of Procurement and Records, a certain contract designated by the parties thereto as **22029PW "Street Paving - Phase X"** dated 15th day of March 2022, shall well and truly keep, do and perform, each and every, all and singular the matters and things in said contract set forth and specified to be by the said Principal kept, done and performed at the time and in the manner in said contract specified, including the payment in full to all and every person furnishing material or performing labor or service or any of them in and about the construction of said contract and the performance of said contract, all and every sum or sums of money due him, them or any of them, for all such labor, services and/or materials, and shall make good and reimburse the above named The City of Wilmington, a municipal corporation, sufficient funds to pay the cost of completing the contract which the obligee may sustain by reason of any failure or default on the part of said Principal, then this obligation shall be void; otherwise, to be and remain in full force and effect.

Provided, however, that any alterations which may be made in the terms of the above-mentioned Contract, or in the work to be done under it or the giving by the Obligee of any extension of time for the performance of the Contract, or any other forbearance on the part of either the obligee or the Principal to the other, shall not in any way release the Principal and/or Surety or either of them, their heirs, executors, administrators, successors, or assign, for liability hereinafter, notice to the Surety of any alteration, extension or forbearance, being hereby expressly waived.

Signed, sealed, and delivered  
in the presence of:

Marley Jayner  
Witness

**SAM'S CONSTRUCTION, LLC.**

By: Samuel Martinez

Samuel Martinez  
Name Typed or Printed

Great Midwest Insurance Company  
Surety Company

By: Gina M. Semorelle  
Gina M. Semorelle, Attorney-In-Fact (Seal)

Address: 707 Philadelphia Pike, Wilmington DE 19809

Telephone: 302-762-7599

**POWER OF ATTORNEY**  
**Great Midwest Insurance Company**

KNOW ALL MEN BY THESE PRESENTS, that **GREAT MIDWEST INSURANCE COMPANY**, a Texas Corporation, with its principal office in Houston, TX, does hereby constitute and appoint:

Richard G. Anderson, Joseph T. Catania, Brent D. Headley, Mary Lawrence, Denise A. Medlar, Gina M. Semonelle, Christopher R. Smith, Gemma B. Fendler

its true and lawful Attorney(s)-In-Fact to make, execute, seal and deliver for, and on its behalf as surety, any and all bonds, undertakings or other writings obligatory in nature of a bond.

This authority is made under and by the authority of a resolution which was passed by the Board of Directors of **GREAT MIDWEST INSURANCE COMPANY**, on the 1<sup>st</sup> day of October, 2018 as follows:

Resolved, that the President, or any officer, be and hereby is, authorized to appoint and empower any representative of the Company or other person or persons as Attorney-In-Fact to execute on behalf of the Company any bonds, undertakings, policies, contracts of indemnity or other writings obligatory in nature of a bond not to exceed Ten Million dollars (\$10,000,000.00), which the Company might execute through its duly elected officers, and affix the seal of the Company thereto. Any said execution of such documents by an Attorney-In-Fact shall be as binding upon the Company as if they had been duly executed and acknowledged by the regularly elected officers of the Company. Any Attorney-In-Fact, so appointed, may be removed in the Company's sole discretion and the authority so granted may be revoked as specified in the Power of Attorney.

Resolved, that the signature of the President and the seal of the Company may be affixed by facsimile on any power of attorney granted, and the signature of the Secretary, and the seal of the Company may be affixed by facsimile to any certificate of any such power and any such power or certificate bearing such facsimile signature and seal shall be valid and binding on the Company. Any such power so executed and sealed and certificate so executed and sealed shall, with respect to any bond of undertaking to which it is attached, continue to be valid and binding on the Company.

IN WITNESS THEREOF, **GREAT MIDWEST INSURANCE COMPANY**, has caused this instrument to be signed by its President, and its Corporate Seal to be affixed this 11th day of February, 2021.



**GREAT MIDWEST INSURANCE COMPANY**

BY Mark W. Haushill  
Mark W. Haushill  
President

**ACKNOWLEDGEMENT**

On this 11th day of February, 2021, before me, personally came Mark W. Haushill to me known, who being duly sworn, did depose and say that he is the President of **GREAT MIDWEST INSURANCE COMPANY**, the corporation described in and which executed the above instrument; that he executed said instrument on behalf of the corporation by authority of his office under the By-laws of said corporation.

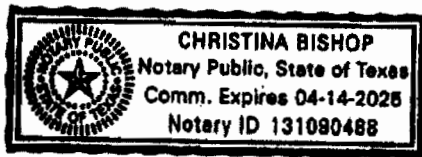

BY Christina Bishop  
Christina Bishop  
Notary Public

**CERTIFICATE**

I, the undersigned, Secretary of **GREAT MIDWEST INSURANCE COMPANY**, A Texas Insurance Company, DO HEREBY CERTIFY that the original Power of Attorney of which the foregoing is a true and correct copy, is in full force and effect and has not been revoked and the resolutions as set forth are now in force.

Signed and Sealed at Houston, TX this 15th Day of March, 2022.



BY Leslie K. Shaunty  
Leslie K. Shaunty  
Secretary

**WARNING: Any person who knowingly and with intent to defraud any insurance company or other person, files and application for insurance of claim containing any materially false information, or conceals for the purpose of misleading, information concerning any fact material thereto, commits a fraudulent insurance act, which is a crime and subjects such person to criminal and civil penalties.**





SAMSCON-01

HANBYD

# CERTIFICATE OF LIABILITY INSURANCE

DATE (MM/DD/YYYY)

3/28/2022

THIS CERTIFICATE IS ISSUED AS A MATTER OF INFORMATION ONLY AND CONFERS NO RIGHTS UPON THE CERTIFICATE HOLDER. THIS CERTIFICATE DOES NOT AFFIRMATIVELY OR NEGATIVELY AMEND, EXTEND OR ALTER THE COVERAGE AFFORDED BY THE POLICIES BELOW. THIS CERTIFICATE OF INSURANCE DOES NOT CONSTITUTE A CONTRACT BETWEEN THE ISSUING INSURER(S), AUTHORIZED REPRESENTATIVE OR PRODUCER, AND THE CERTIFICATE HOLDER.

**IMPORTANT:** If the certificate holder is an **ADDITIONAL INSURED**, the policy(ies) must have **ADDITIONAL INSURED** provisions or be endorsed. If **SUBROGATION IS WAIVED**, subject to the terms and conditions of the policy, certain policies may require an endorsement. A statement on this certificate does not confer rights to the certificate holder in lieu of such endorsement(s).

<b>PRODUCER</b> Insurance Office of America 900 Philadelphia Pike Wilmington, DE 19809	<b>CONTACT NAME:</b> PHONE (A/C, No, Ext): <b>(302) 764-1000</b>	FAX (A/C, No): <b>(302) 764-1152</b>	
	<b>E-MAIL ADDRESS:</b>		
<b>INSURED</b>  Sam's Construction LLC P.O. Box 9827 Wilmington, DE 19809	<b>INSURER(S) AFFORDING COVERAGE</b>		<b>NAIC #</b>
	<b>INSURER A : Atlantic States Insurance Company</b>		<b>22586</b>
	<b>INSURER B : Donegal Mutual Insurance Company</b>		<b>13692</b>
	<b>INSURER C : Peninsula Indemnity Company</b>		<b>39900</b>
	<b>INSURER D :</b>		
	<b>INSURER E :</b>		
<b>INSURER F :</b>			

### COVERAGES

CERTIFICATE NUMBER:

REVISION NUMBER:

THIS IS TO CERTIFY THAT THE POLICIES OF INSURANCE LISTED BELOW HAVE BEEN ISSUED TO THE INSURED NAMED ABOVE FOR THE POLICY PERIOD INDICATED. NOTWITHSTANDING ANY REQUIREMENT, TERM OR CONDITION OF ANY CONTRACT OR OTHER DOCUMENT WITH RESPECT TO WHICH THIS CERTIFICATE MAY BE ISSUED OR MAY PERTAIN, THE INSURANCE AFFORDED BY THE POLICIES DESCRIBED HEREIN IS SUBJECT TO ALL THE TERMS, EXCLUSIONS AND CONDITIONS OF SUCH POLICIES. LIMITS SHOWN MAY HAVE BEEN REDUCED BY PAID CLAIMS.

INSR LTR	TYPE OF INSURANCE	ADDL INSD	SUBR WVD	POLICY NUMBER	POLICY EFF (MM/DD/YYYY)	POLICY EXP (MM/DD/YYYY)	LIMITS
A	<input checked="" type="checkbox"/> COMMERCIAL GENERAL LIABILITY <input type="checkbox"/> CLAIMS-MADE <input checked="" type="checkbox"/> OCCUR  GEN'L AGGREGATE LIMIT APPLIES PER: <input type="checkbox"/> POLICY <input checked="" type="checkbox"/> PROJECT <input type="checkbox"/> LOC <input type="checkbox"/> OTHER:	X		CPA 8098482	4/26/2021	4/26/2022	EACH OCCURRENCE \$ <b>1,000,000</b> DAMAGE TO RENTED PREMISES (Ea occurrence) \$ <b>500,000</b> MED EXP (Any one person) \$ <b>15,000</b> PERSONAL & ADV INJURY \$ <b>1,000,000</b> GENERAL AGGREGATE \$ <b>3,000,000</b> PRODUCTS - COMP/OP AGG \$ <b>3,000,000</b> \$
	<b>AUTOMOBILE LIABILITY</b> <input checked="" type="checkbox"/> ANY AUTO OWNED AUTOS ONLY <input type="checkbox"/> SCHEDULED AUTOS <input type="checkbox"/> HIRED AUTOS ONLY <input type="checkbox"/> NON-OWNED AUTOS ONLY			CAA8098482	4/26/2021	4/26/2022	COMBINED SINGLE LIMIT (Ea accident) \$ <b>1,000,000</b> BODILY INJURY (Per person) \$ BODILY INJURY (Per accident) \$ PROPERTY DAMAGE (Per accident) \$ \$
B	<input checked="" type="checkbox"/> UMBRELLA LIAB <input checked="" type="checkbox"/> OCCUR <input type="checkbox"/> EXCESS LIAB <input type="checkbox"/> CLAIMS-MADE <input type="checkbox"/> DED <input checked="" type="checkbox"/> RETENTION \$ <b>10,000</b>	X		CXL 8098482	4/26/2021	4/26/2022	EACH OCCURRENCE \$ <b>5,000,000</b> AGGREGATE \$ <b>5,000,000</b> \$
C	<b>WORKERS COMPENSATION AND EMPLOYERS' LIABILITY</b> ANY PROPRIETOR/PARTNER/EXECUTIVE OFFICER/MEMBER EXCLUDED? (Mandatory in NH) <input type="checkbox"/> Y/N If yes, describe under DESCRIPTION OF OPERATIONS below		N/A	1000024943	4/26/2021	4/26/2022	<input checked="" type="checkbox"/> PER STATUTE <input type="checkbox"/> OTH-ER E.L. EACH ACCIDENT \$ <b>1,000,000</b> E.L. DISEASE - EA EMPLOYEE \$ <b>1,000,000</b> E.L. DISEASE - POLICY LIMIT \$ <b>1,000,000</b>

DESCRIPTION OF OPERATIONS / LOCATIONS / VEHICLES (ACORD 101, Additional Remarks Schedule, may be attached if more space is required)

Re: Contract No. 22029PW - Street Paving, Phase X  
City of Wilmington is additional insured for general liability for ongoing operations per written contract requirement per carrier form CGD2033.

### CERTIFICATE HOLDER

### CANCELLATION

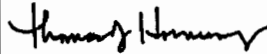
<b>CITY OF WILMINGTON</b> DEPARTMENT OF FINANCE, DIVISION OF PROCUREMENT LOUIS REDDING CITY COUNTY BUILDING 800 N. FRENCH STREET, 5TH FLOOR Wilmington, DE 19801	SHOULD ANY OF THE ABOVE DESCRIBED POLICIES BE CANCELLED BEFORE THE EXPIRATION DATE THEREOF, NOTICE WILL BE DELIVERED IN ACCORDANCE WITH THE POLICY PROVISIONS.  AUTHORIZED REPRESENTATIVE 
--	---

LICENSE NO. 2002104004 DORBL

STATE OF DELAWARE

VALID

POST CONSPICUOUSLY

DIVISION OF REVENUE

01/01/20 - 12/31/22  
NOT TRANSFERABLE

DLN: 19 92600 50

BUSINESS CODE 331  
GROUP CODE

LICENSED CONTRACTOR-RESIDENT  
ACTIVITY

DATE ISSUED: 11/18/19

\*\*VALIDATED\*\*

2022

LICENSE FEE: \$ 225.00

MAILING ADDRESS

BUSINESS LICENSE

BUSINESS LOCATION

SAMS CONSTRUCTION LLC  
PO BOX 9827  
WILMINGTON DE 19809-0827



SAMS CONSTRUCTION LLC  
1227 E 15TH ST  
WILMINGTON DE 19802-5214

IS HEREBY LICENSED TO PRACTICE, CONDUCT OR ENGAGE IN THE OCCUPATION  
OR BUSINESS ACTIVITY INDICATED ABOVE IN ACCORDANCE WITH THE LICENSE  
APPLICATION DULY FILED PURSUANT TO TITLE 30, DEL CODE.

JENNIFER R. HUDSON

DIRECTOR OF REVENUE

CITY OF WILMINGTON - BUSINESS LICENSE

ACCOUNT NO.

LICENSE NO.

CODE

FEE PAID

022048

2502

1002

CEMENT - CONCRETE - STONE - MA

\$120.00

BUSINESS

SAM'S CONSTRUCTION LLC  
1227 E 15TH ST  
WILMINGTON, DE 19802

Expires: 12/31/2022

ISSUED BY

SAM'S CONSTRUCTION LLC  
PO BOX 9827  
WILMINGTON, DE 19809

*Jeffrey J. Starkey*

COMMISSIONER  
DEPARTMENT OF LICENSES & INSPECTIONS

THIS LICENSE MUST BE DISPLAYED IN A PROMINENT PLACE

----- CONTRACT-----

**THIS AGREEMENT** made the 15<sup>th</sup> day of **March** in the year **Two Thousand Twenty-Two** and between the City of Wilmington, a municipal corporation of the State of Delaware, acting through the agency of the Department of Finance, Division of Procurement and Records, party of the first part (hereinafter designated the Owner), and **SAM'S CONSTRUCTION, LLC** party of the second part (hereinafter designated the Contractors)

**WITNESSETH**, that the Contractor, in consideration of agreements herein made by the Owner, agrees with the Owner as follows:

Article 1. The Contractor shall and will furnish and deliver per specifications, on contract **22029PW "Street Paving Phase X"** for the **Department of Public Works** in accordance with Advertisement for Bids by the Department of Finance, Division of Procurement and Records date **1/6/22 and 1/13/22** and per specifications identified as Contract No. **22029PW** and by the signatures of the parties hereto, are, together with the said Advertisement for Bids, Instructions to Bidders, Forms of Proposal, and/or other documents pertinent thereto, hereby acknowledge and incorporated into these presents and are to be taken as a part of this Contract.

Article 2. It is understood and agreed by and between the parties hereto that the amount of this Contract is in the amount of **Two Million Seven Hundred Eleven Thousand Seven Hundred Sixty Two ----- Dollars and----- 70/100 (\$2,711,762.70)** as per Proposal dated **2/10/22** to the Department of Finance, Division of Procurement and Records.

Article 3. In the performance of this Contract, the parties agree that they shall not discriminate or harass, or permit discrimination or harassment, against any person because of age sex, marital status, race, religion, color, national origin, or sexual orientation.

Article 4. This Agreement shall bind the heirs, executors, administrators, successors and assigns to the respective parties hereto.

In witness whereof the party of the first part has, by recommendation of the **Commissioner of Public Works**, caused the hand of **Michael S. Purzycki**, Mayor, and the corporate seal of the City of Wilmington, attested by the City Clerk, to be hereunto affixed; and the party of the second part has caused the hand of its' President, (or his authorized representative) and its' corporate seal, attested by the Secretary or assistant Secretary, to be hereunto affixed.

Dated the day and year first above written in the City of Wilmington, County of New Castle, State of Delaware.

Signed, Sealed and delivered  
in the presence of:

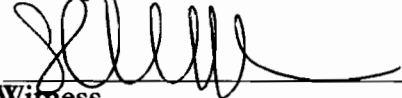
  
Witness

THE CITY OF WILMINGTON

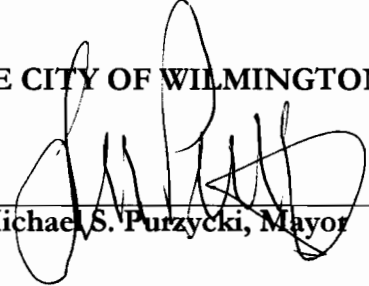
By:   
Michael S. Purzycki, Mayor

ATTEST:

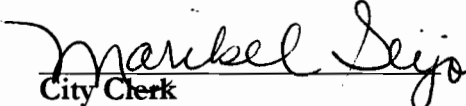
  
City Clerk

SAM'S CONSTRUCTION, LLC

  
Witness

By:   
Samuel Martinez, President (Seal)

ATTEST:

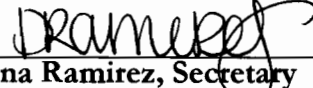
  
Diana Ramirez, Secretary



SAMSCON-01

HANBYD

# CERTIFICATE OF LIABILITY INSURANCE

DATE (MM/DD/YYYY)  
3/28/2022

THIS CERTIFICATE IS ISSUED AS A MATTER OF INFORMATION ONLY AND CONFERS NO RIGHTS UPON THE CERTIFICATE HOLDER. THIS CERTIFICATE DOES NOT AFFIRMATIVELY OR NEGATIVELY AMEND, EXTEND OR ALTER THE COVERAGE AFFORDED BY THE POLICIES BELOW. THIS CERTIFICATE OF INSURANCE DOES NOT CONSTITUTE A CONTRACT BETWEEN THE ISSUING INSURER(S), AUTHORIZED REPRESENTATIVE OR PRODUCER, AND THE CERTIFICATE HOLDER.

**IMPORTANT:** If the certificate holder is an ADDITIONAL INSURED, the policy(ies) must have ADDITIONAL INSURED provisions or be endorsed. If SUBROGATION IS WAIVED, subject to the terms and conditions of the policy, certain policies may require an endorsement. A statement on this certificate does not confer rights to the certificate holder in lieu of such endorsement(s).

<b>PRODUCER</b> Insurance Office of America 900 Philadelphia Pike Wilmington, DE 19809	<b>CONTACT NAME:</b> PHONE (A/C, No, Ext): (302) 764-1000		<b>FAX (A/C, No):</b> (302) 764-1152
	<b>E-MAIL ADDRESS:</b>		
	<b>INSURER(S) AFFORDING COVERAGE</b>		<b>NAIC #</b>
	<b>INSURER A : Atlantic States Insurance Company</b>		<b>22586</b>
	<b>INSURER B : Donegal Mutual Insurance Company</b>		<b>13692</b>
	<b>INSURER C : Peninsula Indemnity Company</b>		<b>39900</b>
<b>INSURER D :</b>			
<b>INSURER E :</b>			
<b>INSURER F :</b>			
<b>INSURED</b>  Sam's Construction LLC P.O. Box 9827 Wilmington, DE 19809			

**COVERAGES                                  CERTIFICATE NUMBER:                                  REVISION NUMBER:**

THIS IS TO CERTIFY THAT THE POLICIES OF INSURANCE LISTED BELOW HAVE BEEN ISSUED TO THE INSURED NAMED ABOVE FOR THE POLICY PERIOD INDICATED. NOTWITHSTANDING ANY REQUIREMENT, TERM OR CONDITION OF ANY CONTRACT OR OTHER DOCUMENT WITH RESPECT TO WHICH THIS CERTIFICATE MAY BE ISSUED OR MAY PERTAIN, THE INSURANCE AFFORDED BY THE POLICIES DESCRIBED HEREIN IS SUBJECT TO ALL THE TERMS, EXCLUSIONS AND CONDITIONS OF SUCH POLICIES. LIMITS SHOWN MAY HAVE BEEN REDUCED BY PAID CLAIMS.

INSR LTR	TYPE OF INSURANCE	ADDL INSD	SUBR WVD	POLICY NUMBER	POLICY EFF (MM/DD/YYYY)	POLICY EXP (MM/DD/YYYY)	LIMITS	
<b>A</b>	<input checked="" type="checkbox"/> <b>COMMERCIAL GENERAL LIABILITY</b> <input type="checkbox"/> CLAIMS-MADE <input checked="" type="checkbox"/> OCCUR GEN'L AGGREGATE LIMIT APPLIES PER: <input type="checkbox"/> POLICY <input checked="" type="checkbox"/> PROJECT <input type="checkbox"/> LOC <input type="checkbox"/> OTHER:			<b>CPA 8098482</b>	<b>4/26/2021</b>	<b>4/26/2022</b>	EACH OCCURRENCE	\$ <b>1,000,000</b>
							DAMAGE TO RENTED PREMISES (Ea occurrence)	\$ <b>500,000</b>
							MED EXP (Any one person)	\$ <b>15,000</b>
							PERSONAL & ADV INJURY	\$ <b>1,000,000</b>
							GENERAL AGGREGATE	\$ <b>3,000,000</b>
							PRODUCTS - COMP/OP AGG	\$ <b>3,000,000</b>
								\$
	<input checked="" type="checkbox"/> <b>AUTOMOBILE LIABILITY</b> <input type="checkbox"/> ANY AUTO OWNED AUTOS ONLY <input type="checkbox"/> SCHEDULED AUTOS <input type="checkbox"/> HIRED AUTOS ONLY <input type="checkbox"/> NON-OWNED AUTOS ONLY			<b>CAA8098482</b>	<b>4/26/2021</b>	<b>4/26/2022</b>	COMBINED SINGLE LIMIT (Ea accident)	\$ <b>1,000,000</b>
							BODILY INJURY (Per person)	\$
							BODILY INJURY (Per accident)	\$
							PROPERTY DAMAGE (Per accident)	\$
								\$
<b>B</b>	<input checked="" type="checkbox"/> <b>UMBRELLA LIAB</b> <input checked="" type="checkbox"/> OCCUR <input type="checkbox"/> EXCESS LIAB <input type="checkbox"/> CLAIMS-MADE <input type="checkbox"/> DED <input checked="" type="checkbox"/> RETENTION \$ <b>10,000</b>			<b>CXL 8098482</b>	<b>4/26/2021</b>	<b>4/26/2022</b>	EACH OCCURRENCE	\$ <b>5,000,000</b>
							AGGREGATE	\$ <b>5,000,000</b>
								\$
<b>C</b>	<b>WORKERS COMPENSATION AND EMPLOYERS' LIABILITY</b> ANY PROPRIETOR/PARTNER/EXECUTIVE OFFICER/MEMBER EXCLUDED? (Mandatory in NH) <input type="checkbox"/> Y <input checked="" type="checkbox"/> N If yes, describe under DESCRIPTION OF OPERATIONS below			<b>1000024943</b>	<b>4/26/2021</b>	<b>4/26/2022</b>	<input checked="" type="checkbox"/> PER STATUTE <input type="checkbox"/> OTHER	
							E.L. EACH ACCIDENT	\$ <b>1,000,000</b>
							E.L. DISEASE - EA EMPLOYEE	\$ <b>1,000,000</b>
							E.L. DISEASE - POLICY LIMIT	\$ <b>1,000,000</b>

DESCRIPTION OF OPERATIONS / LOCATIONS / VEHICLES (ACORD 101, Additional Remarks Schedule, may be attached if more space is required)  
Re: Contract No. 22029PW - Street Paving, Phase X  
City of Wilmington is additional insured for general liability for ongoing operations per written contract requirement per carrier form CGD2033.

**CERTIFICATE HOLDER                                  CANCELLATION**

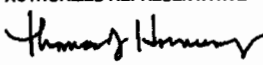
<b>CITY OF WILMINGTON</b> DEPARTMENT OF FINANCE, DIVISION OF PROCUREMENT LOUIS REDDING CITY COUNTY BUILDING 800 N. FRENCH STREET, 5TH FLOOR Wilmington, DE 19801	SHOULD ANY OF THE ABOVE DESCRIBED POLICIES BE CANCELLED BEFORE THE EXPIRATION DATE THEREOF, NOTICE WILL BE DELIVERED IN ACCORDANCE WITH THE POLICY PROVISIONS.  AUTHORIZED REPRESENTATIVE 
--	---

LICENSE NO. 2002104004 DORBL

STATE OF DELAWARE  
DIVISION OF REVENUE

**VALID**  
01/01/20 - 12/31/22  
NOT TRANSFERABLE

POST CONSPICUOUSLY

PLN: 19 92600 50

BUSINESS CODE 331  
GROUP CODE

LICENSED ACTIVITY CONTRACTOR-RESIDENT

DATE ISSUED: 11/18/19

**\*\*VALIDATED\*\***

**2022**

LICENSE FEE: \$ 225.00

MAILING ADDRESS

**BUSINESS LICENSE**

BUSINESS LOCATION

SAMS CONSTRUCTION LLC  
PO BOX 9827  
WILMINGTON DE 19809-0827



SAMS CONSTRUCTION LLC  
1227 E 15TH ST  
WILMINGTON DE 19802-5214

IS HEREBY LICENSED TO PRACTICE, CONDUCT OR ENGAGE IN THE OCCUPATION  
OR BUSINESS ACTIVITY INDICATED ABOVE IN ACCORDANCE WITH THE LICENSE  
APPLICATION DULY FILED PURSUANT TO TITLE 30, DEL CODE.

JENNIFER R. HUDSON

DIRECTOR OF REVENUE

**CITY OF WILMINGTON - BUSINESS LICENSE**

ACCOUNT NO.

LICENSE NO.

CODE

FEE PAID

022048

2502

1002

CEMENT-CONCRETE-STONE-MA

\$120.00

BUSINESS

SAM'S CONSTRUCTION LLC  
1227 E 15TH ST  
WILMINGTON, DE 19802

Expires: 12/31/2022

ISSUED BY

SAM'S CONSTRUCTION LLC  
PO BOX 9827  
WILMINGTON, DE 19809

*Jeffrey J. Starkey*

COMMISSIONER  
DEPARTMENT OF LICENSES & INSPECTIONS

THIS LICENSE MUST BE DISPLAYED IN A PROMINENT PLACE